

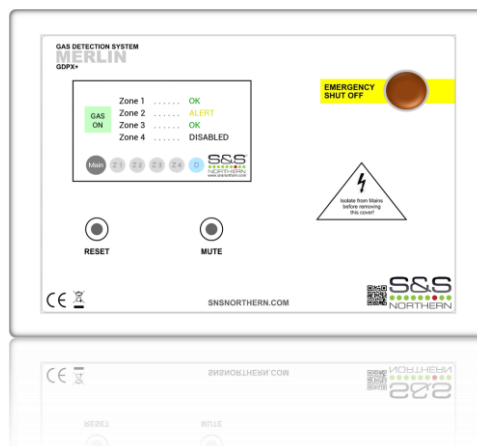

Merlin Gas Detection Panel: GDPX+



Installation & Operation Manual

Please read this manual carefully and retain for future use.

S&S Northern provide a range of detection panels which can be used in many applications such as factories, car parks, shopping centres and most commonly for this model - boiler houses.

The GDPX+ can be used with up to 16 Merlin gas detectors (sold separately) for monitoring and detecting gas including carbon monoxide, liquid petroleum gas and methane.

CONTENTS

- INSTALLATION3**
- Planning 3
- Quick Installation Arrangement 3
- Fixing 4
- Board Overview - Main 4
- Wiring the GDPX+ 5
- Settings Switch 10
- Settings Menu 10
- Settings Options Explained 11
- Factory Set Condition 11
- Connecting to the Internet 12
- Trouble Shooting 12
- Specification 12

- OPERATION13**
- First Power Up 13
- Main Screen 13
- Zone Screens 13
- Diagnostic Screen 14
- Fire Alarm Bypass 14
- Alarm Messages 14
- Alarm Message List 15
- Servicing & General Maintenance 16
- Bump Testing 17

- IMPORTANT WARNING STATEMENTS18**
- Manufacturer's Warranty 18
- Installation Details 20

INSTALLATION

Planning

The Merlin GDPX+ is a multi-zone gas detection panel which can be used in many applications such as factories, car parks, shopping malls and most commonly - boiler houses.

It can be used with up to 16 Merlin gas detectors (model X) for monitoring and detecting gas including carbon monoxide, liquid petroleum gas and methane. The GDPX+ also has provisions to identify and monitor gas levels via an internet connection.

The GDPX+ system can be integrated with, but not limited to, a BMS (building management system) including Modbus, a fire panel, external alarms and remote emergency shut-off buttons.



Please refer to your detector manual for important information regarding coverage, location and positioning including areas and conditions to avoid.

Locations for detectors will vary based on the intended application and target gas, they should be located near identified sources of a potential gas leaks/ pockets where hazardous gas could quickly accumulate and areas of identified consequential risk.

The composition of the target gas and its density relative to air are used as the basis for any recommended height of sensors.

Generally, the installation height of a sensor for a heavy gas (such as propane) would be close to the lowest point in the area, and for a light gas (such as methane) would be close to the highest point in the area. Any recommended heights may vary based on air flow and temperature conditions in addition to the proposed application and location – this is particularly apparent with oxygen depletion sensors, and the target gas that they are used for.

Quick Installation Arrangement

Placing the GDPX+ at eye level allows for optimum monitoring of the display screen.

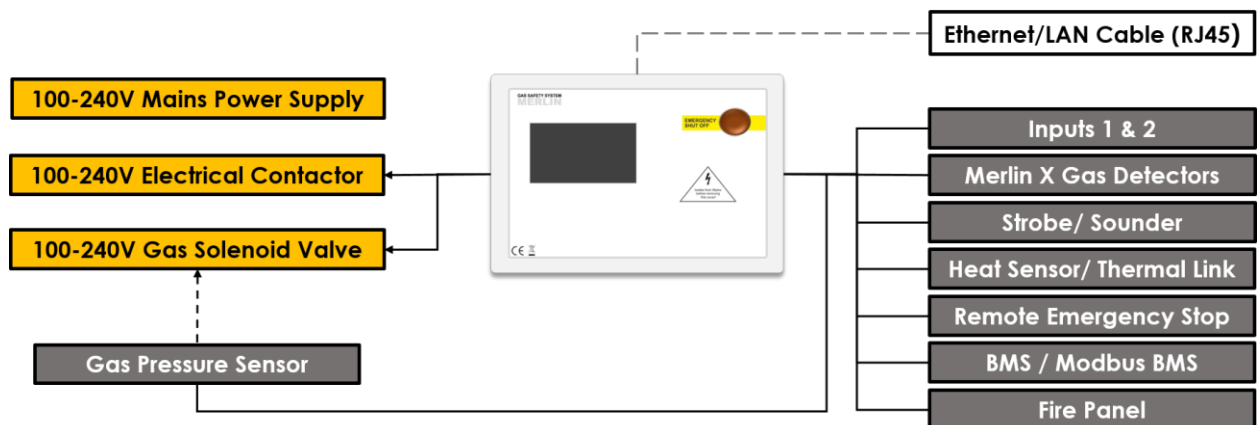



For applications where gas monitoring may exceed 100 metres from one control panel – Contact your supplier.

Fixing

Unpack all the parts!

1. Carefully remove the front cover from the unit by unscrewing the four bolts located at each corner. To do this – use the socket wrench provided.
2. Mark the four screw holes located on the back of the enclosure to the wall. Ensure the wall surface is flat to prevent base distortion.
3. After executing the mounting and the connections – replace the front cover and insert the security caps over the four bolts.

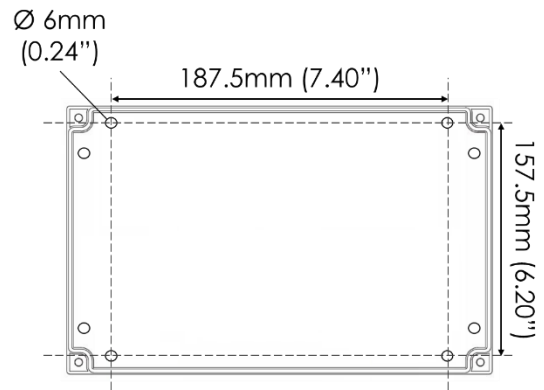

⚠

Be careful when creating access for cables – Damage to boards will void any warranty.

Board Overview - Main

Volt Free Open/Close Switch Connections

- Input #1
- Input #2
- Fire Panel
 - Heat Sensor
 - Remote Emergency Stop

⚠

To avoid electrical shock you must always isolate the mains supply before opening the GDPX+ panel cover/s.

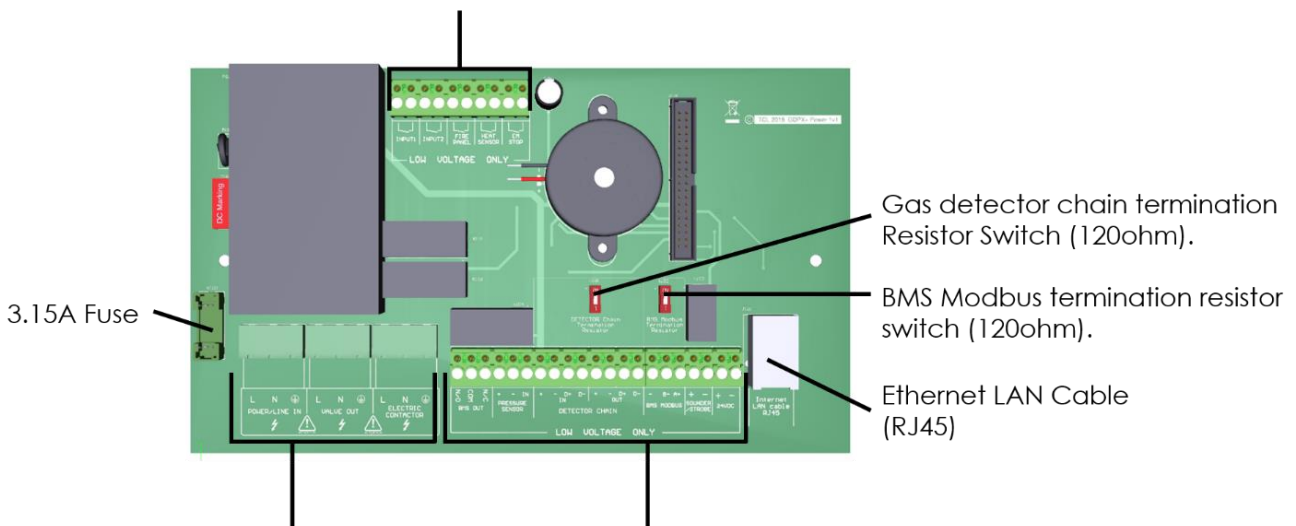

- 100-240VAC**
- Power / Line In
 - Gas Valve output
 - Electrical Contactor



- Low Voltage Connections**
- BMS Relay output
 - Pressure Sensor input
 - Gas Detectors
 - BMS Modbus
 - Sounder/ Strobe output
 - 24VDC Permanent output (200mA max)

Wiring the GDPX+



Always power down the panel when wiring external circuits to prevent damage to electronics.



Mains supply must be connected by a competent person and according to any regulations.

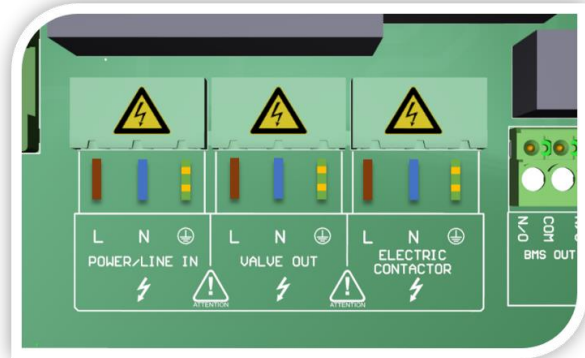

MAINS POWER CONNECTION

100-240V AC mains power should be supplied to the **[POWER/LINE IN]** connector using a 3 core cable and fused at 3A.

On connecting the mains supply to the panel the power LED indicator will light up – this is located on the front cover (red dot on the S&S Northern Logo).



VALVE OUTPUT

100-240V AC electrical power supplied from the **[VALVE OUT]** connector using a 3 core cable can be connected to a gas solenoid valve which can shut the gas supply on alarm status.

A pressure sensor should be connected to the downstream port.

Refer to your valve manual for more information and wiring!

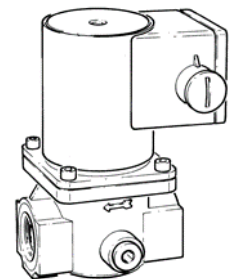

ELECTRIC CONTACTOR OUTPUT

100-240V AC electrical power supplied from the **[ELECTRIC CONTACTOR]** connector using a 3 core cable can be connected to a contactor.

Refer to your contactor manual for more information and wiring!

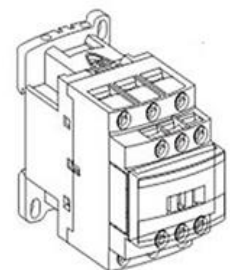

BMS OUTPUT

Connections are available on the board for Building Management Systems.

[NO] [COM] [NC]

These are volt free connections.

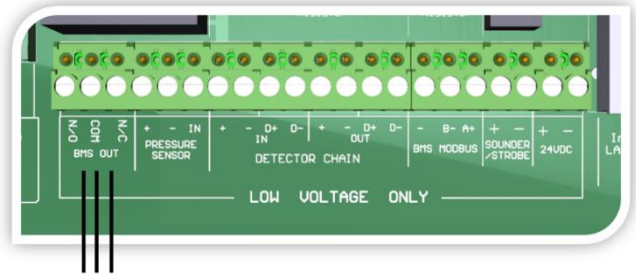

This is a relay that changes state in alarm or when the gas is on/off and can be used in conjunction with the 24V DC output and other external relays that affect other devices and controls such as purge fans and audible alarms etc.

PRESSURE SENSOR

The pressure sensor is wired to the **[PRESSURE SENSOR]** connector and screwed into the downstream port of the gas solenoid valve.

Connect the pressure sensor as shown:

Red **[+]** Black **[-]** Blue **[IN]**

The sensor will monitor the gas supply pressure and if pressure drops below 12mbar – the gas valve will close as this could mean a gas leak is present.

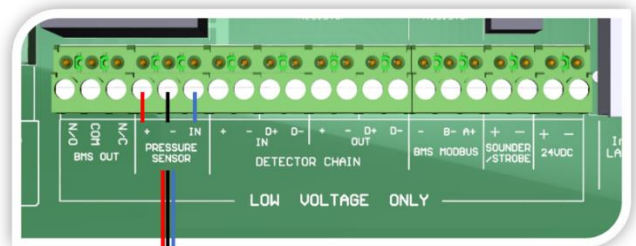

⚠ Screw the pressure sensor into the downstream port of your gas solenoid valve.

Gas pressure will be ignored if gas proving is OFF.

More information on gas proving can be found in the **[SETTINGS]** section of this manual.

The pressure sensor operating pressure is: 0-100mbar.

GAS DETECTORS

A 12-24V power and data supply to gas detectors are wired to **[DETECTOR CHAIN]** connectors.

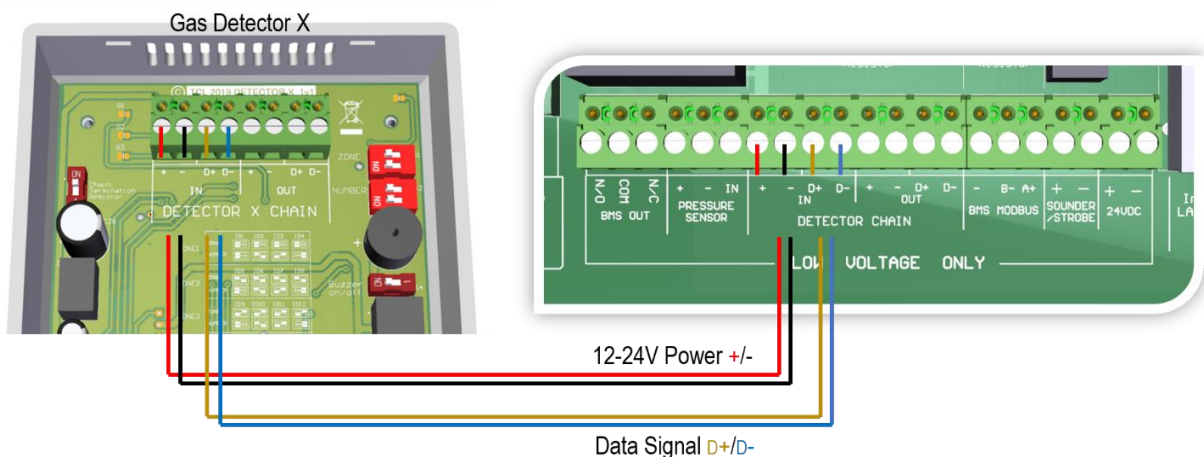

12-24V power and data supply from your GDPX+ **[DETECTOR CHAIN]** to **[DETECTOR X CHAIN]** can be wired in any configuration. i.e. **[IN/IN]** **[OUT/OUT]** **[IN/OUT]** **[OUT/IN]** etc.

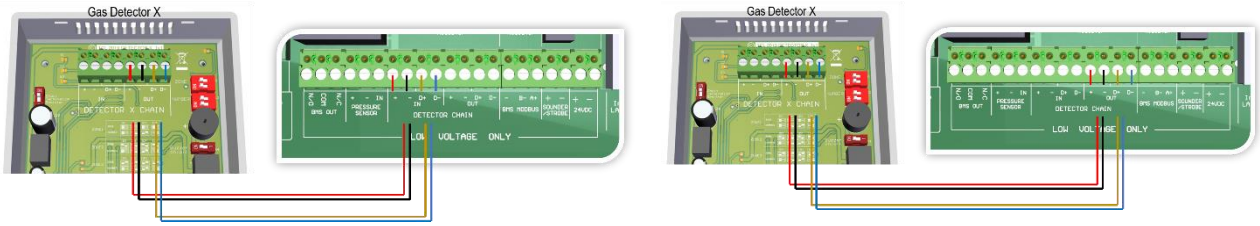

MULTIPLE DETECTOR CHAIN SYSTEM - TYPICAL EXAMPLES

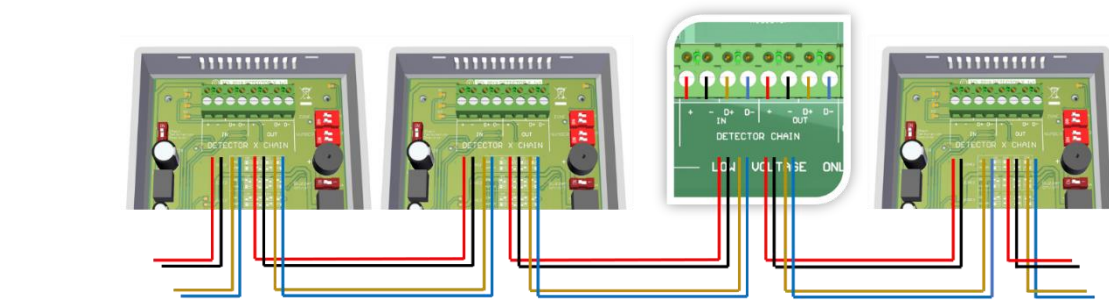
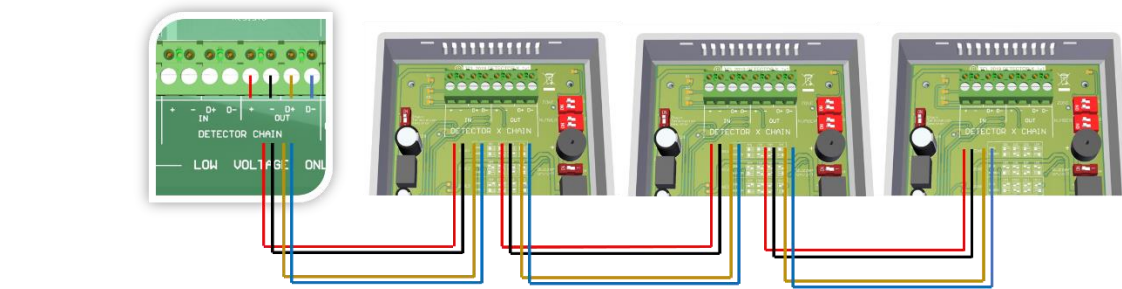

DETECTOR – ID SETUP.

When wiring multiple model 'X' detectors to the GDPX+ range it is important to identify each detector and in which monitoring zone the detector is located - for the GDP-X system to receive and display data.

ID switches are fitted to detector circuit boards.

The diagram opposite shows how to configure switches for each detector and is also printed onto the detector circuit boards for quick reference.

Refer to your detector manual.

	ID 1	ID 2	ID 3	ID 4
ZONE1	ZONE	<input type="checkbox"/>	<input type="checkbox"/>	<input type="checkbox"/>
	NUMBER	<input type="checkbox"/>	<input type="checkbox"/>	<input type="checkbox"/>
	ID 5	ID 6	ID 7	ID 8
ZONE2	ZONE	<input type="checkbox"/>	<input type="checkbox"/>	<input type="checkbox"/>
	NUMBER	<input type="checkbox"/>	<input type="checkbox"/>	<input type="checkbox"/>
	ID 9	ID 10	ID 11	ID 12
ZONE3	ZONE	<input type="checkbox"/>	<input type="checkbox"/>	<input type="checkbox"/>
	NUMBER	<input type="checkbox"/>	<input type="checkbox"/>	<input type="checkbox"/>
	ID 13	ID 14	ID 15	ID 16
ZONE4	ZONE	<input type="checkbox"/>	<input type="checkbox"/>	<input type="checkbox"/>
	NUMBER	<input type="checkbox"/>	<input type="checkbox"/>	<input type="checkbox"/>

DETECTOR CHAIN TERMINATION

⚠ DETECTOR Chain Termination Resistor Switch

Signal communication issues may occur where the bus length is too long or high baud rates are used. In this instance – *terminating at each end* of the chain may help the quality of the data signal. To do this - turn on the **[CHAIN TERMINATION RESISTOR]** switches shown below.

Example 1.

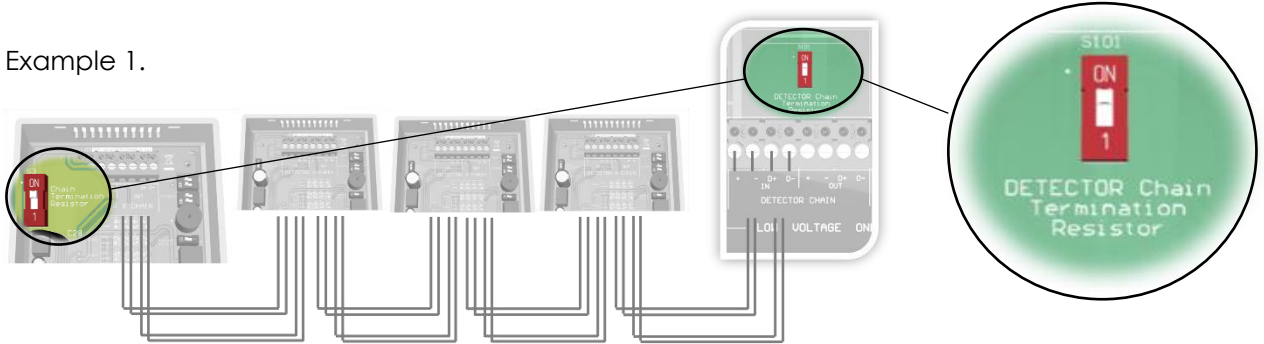

Example 2.

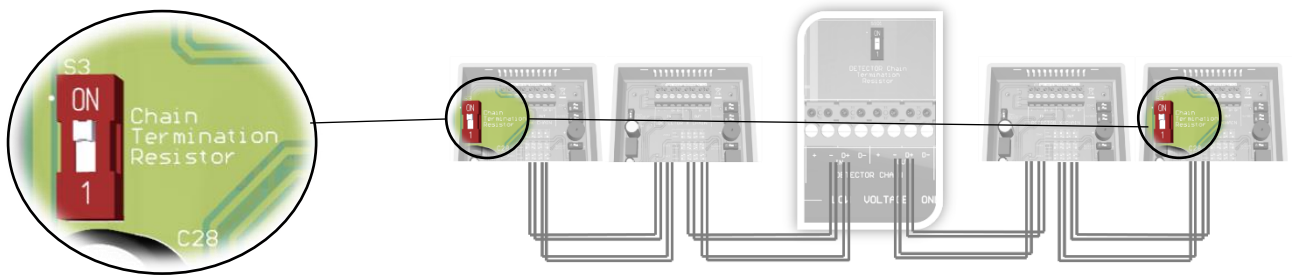

BMS MODBUS - RTU

Connections are available for Master/Slave protocols used in Building Management Systems to communicate between devices including the GDPX+ panel.

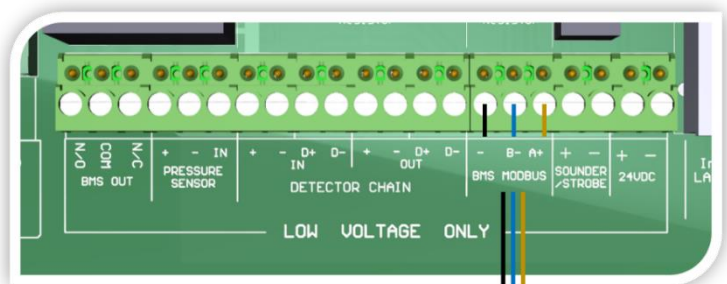
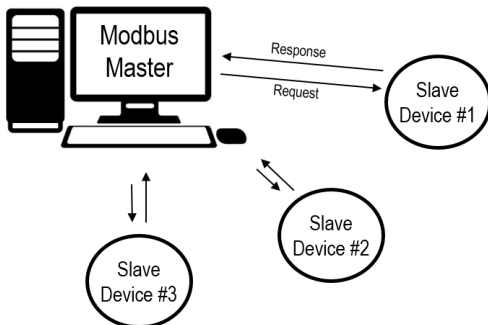

Ground / 0V
Data Signal B- / A+

⚠ BMS MODBUS Termination Resistor Switch

Signal communication issues may occur where the bus length is too long or high baud rates are used.

In this instance – the BMS Modbus Termination Switch may help the quality of the data signal when turned on.

SOUNDER-STROBE

There are connections for an external sounder alarm/ strobe lighting to activate on alarm.

Refer to your sounder/ strobe manual for wiring.

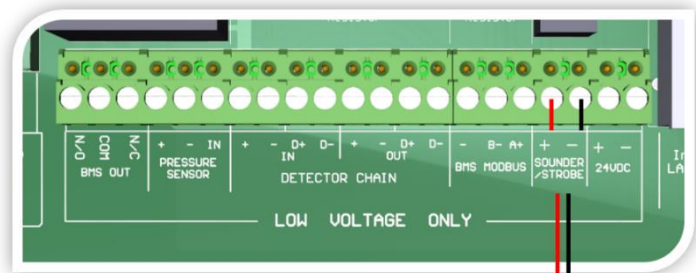

24V DC Output to Sounder/ Strobe Alarm

24V DC OUTPUT

This is a permanent 24V DC power output for external auxiliary devices.

Max output: 200mA

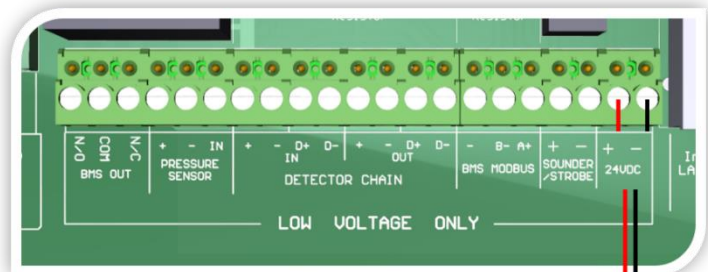

Permanent 24V DC Output

These terminals are volt free and fitted with links to represent a closed circuit.

INPUT 1 & INPUT 2

These terminals are connections for selectable external devices which send an 'open/close' circuit signal to the GDP-X panel such as a current monitor, CO2 monitor or extra emergency shut buttons and heat sensors - selectable in the Settings menu.

FIRE PANEL

The terminal for fire alarms is detailed on the circuit board as [FIRE PANEL].

HEAT SENSOR

The terminal for heat sensors/ thermal links is detailed as [HEAT SENSOR]. Additional Heat Sensors can be connected to [INPUT 1] or [INPUT 2] terminals.

EM STOP

Connections for remote emergency shut-off or stop buttons is detailed on the circuit board as [EM STOP]. Additional shut-off buttons can be connected to [INPUT 1] or [INPUT 2] terminals.

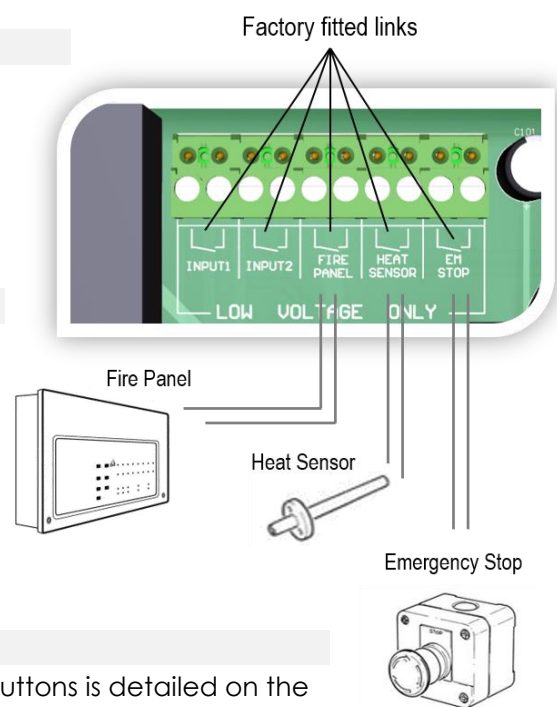

Settings Switch

On the front fascia circuit board you'll find a SETTINGS dip-switch – when switched to ON, the screen will display the settings menu – you can now configure your GDPX+.

To view, change and save settings, you must provide mains power to [POWER/LINE IN].

When changes have been made – turn the SETTINGS switch OFF and the system will automatically restart.

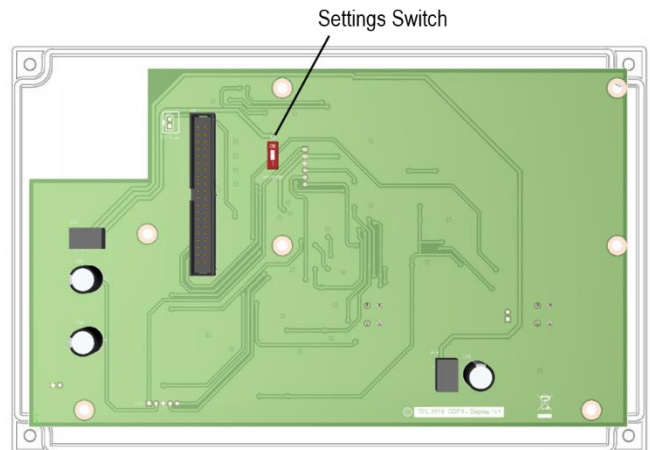

Settings Menu

The GDPX+ has a touch screen which allows the engineer/ user to configure the system. There are two menu screens which are selectable by touching either page number (1 or 2).

Page 1

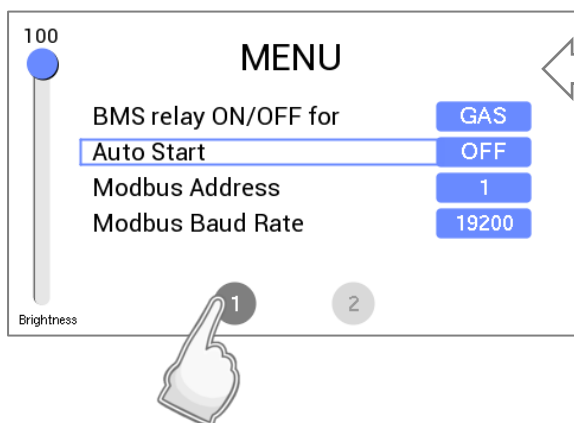

Page 2

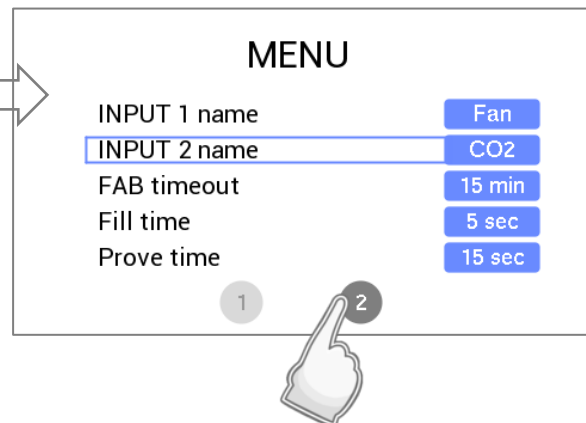

Adjust the screen brightness.

Press or slide the cursor up and down.

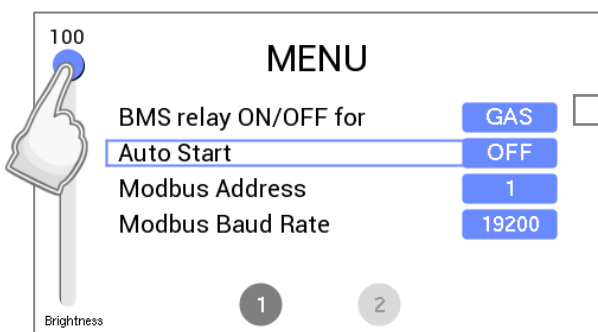

Change/Select option

Press the blue option box or press and hold.

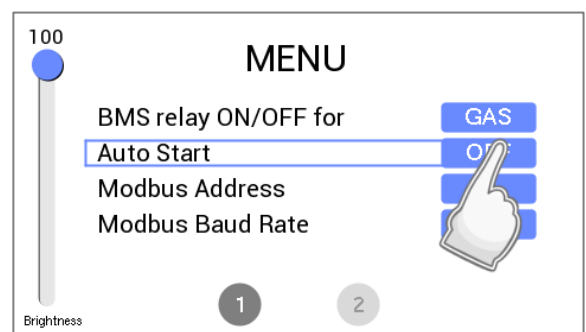

When changes have been made – turn the SETTINGS switch OFF and the system will automatically restart.

Settings Options Explained

FUNCTION	OPTIONS	Explanation
BMS relay ON/OFF for-	- Gas - Error	Gas changes relay state with gas valve status only. Error changes relay state upon all alarm messages.
Auto Start-	- ON - OFF	In the event of a power loss - the GDPX+ will restart automatically when power is restored, or not.
Modbus Address-	- 1-32	GDPX+ panel address form master BMS Modbus.
Modbus Baud Rate-	- 9600 - 19200 - 38400 - 57600 - 115200	Modbus data exchange speed (bit per second).
INPUT 1 name-	- FAN - NG - CO - LPG - CO2 - EM - HS	External devices connected to [INPUT 1] terminal i.e. gas detectors, emergency stops, heat sensors, fans and CO2 monitors.
INPUT 2 name-	- FAN - NG - CO - LPG - CO2 - EM - HS	External devices connected to [INPUT 2] terminal i.e. gas detectors, emergency stops, heat sensors, fans and CO2 monitors.
FAB timeout-	- 15 min - 30 min - 45 min	Time (in minutes) that the Fire Alarm Bypass (FAB) feature will be enabled upon each activation.
Fill time	- OFF - 5 sec - 10 sec	Time (seconds) the gas valve is open to fill the gas line on power up or reset. Prove time must be selected.
Prove time-	- OFF - 30 sec - 50 sec	Time (seconds) the GDPX+ tests the gas line for leaks on power up or reset (<12mbar). Fill time must be selected.

Factory Set Condition

Screen Brightness-	- 100	INPUT 1 name-	- FAN
BMS relay ON/OFF for-	- Gas	INPUT 2 name-	- FAN
Auto Start-	- OFF	FAB timeout-	- 30 min
Modbus Address-	- 1	Fill time-	- OFF
Modbus Baud Rate-	- 19200	Prove time-	- OFF

Connecting to the Internet



Simply connect your LAN cable into the LAN cable port on the GDPX+ board.

Trouble Shooting

Fault.	Possible Cause/Correction.
Detector not responding.	<ul style="list-style-type: none"> ○ Incorrect wiring. ○ ID switches not properly configured. ○ Termination switches not set up correctly.
Service message	<ul style="list-style-type: none"> ○ Detector requires service – contact supplier.
End of Life message	<ul style="list-style-type: none"> ○ Detector requires replacement – contact supplier.
No internet connection	<ul style="list-style-type: none"> ○ Contact internet provider. ○ Reset GDPX+.
Gas proving not working	<ul style="list-style-type: none"> ○ Fill time or gas proving not selected in menu. Both must be ON. ○ Pressure Sensor not connected to downstream port of gas valve.

Specification

Product:	Gas Detection Panel
Model:	GDPX+
Display	4.3" Touch Screen TFT
Power Input Voltage	100-240V AC
Gas Valve Output Voltage	100-240V AC
Electrical Contactor Output Voltage	100-240V AC
BMS Max Output	3A
BMS Modbus protocol	RTU
Current Consumption	48W max (fully loaded)
Internal Fuse	3.15A
Operating Temperature	0 – 50°C (32 – 122°F) 30-85%RH Non-Condensing
Audible Alarm Buzzer dB	65 dB (300mm distance in quiet conditions)
Pressure Sensor Operating Pressure	0 - 100mbar
Internet connection	Ethernet (RJ45)
Housing Material	Polylac PA-765
Flame Rating	UL 94
Approvals	CE, RoHS
O/All Dimensions (H x W x D) mm	180 x 255 x 77mm

OPERATION

First Power Up

On connecting mains power, the GDPX+ panel will 'warm up' for approximately 60 seconds – during this time the screen will display an 'initialisation' message.

If gas proving is configured in the settings menu – the screen will display the gas pressure whilst testing the gas line for leaks. The panel will then search for detectors connected to the GDPX+ panel.



Main Screen

When the GDPX+ has completed initialising and gas proving has been successful – the Main screen will appear.

The Main screen gives an overview of the status of each zone being monitored by gas detectors and if the gas supply is on or off (detectors sold separately).

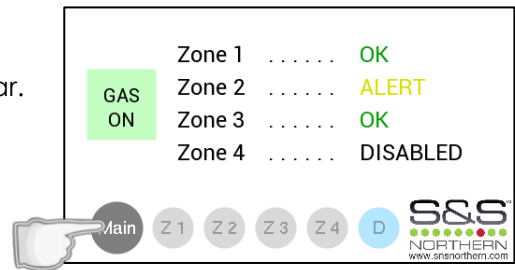

ZONE STATUS EXPLANATION

- OK**
 - Gas levels are safe.
 - No error conditions.
- ALERT**
 - Detector(s) are in Pre-Alarm status.
 - Detector(s) require service.
 - Detector gas sensor(s) end of life.
- ALARM**
 - Dangerous gas levels detected. (Gas is shut off).
 - Detector gas sensor fault or detector(s) disconnected. (Gas is shut off).
- DISABLED**
 - No detector signals are received from the zone.

Zone Screens

Switch between zone screens by touching the relevant zone screen, i.e. Z1, Z2, Z3 and Z4.

Each zone can display up to 4 detectors as follows:

- a. The detector identification number (configured via dip switches on the detector circuit board).
- b. The unique serial number for that detector.
- c. The target gas that the detector is monitoring.
- d. The status of gas levels, errors and messages.
- e. The concentration value of gas being monitored.

	a	b	c	d	e
	ID	Serial Number	Gas	Status	Value
	1	123456789103	CO	GOOD	12 ppm
	2	123456789103	CO	GOOD	2 ppm
	3	123456789103	CO	GOOD	0 ppm
	4	123456789103	LPG	GOOD	5.4 LEL%

Diagnostic Screen

Touching the Diagnostic screen (D) will display three characteristics of the GDPX+.

- Gas supply pressure monitored by the pressure sensor connected to the downstream port of the gas valve.
- Fire Alarm Bypass (FAB) (Enable/disable).
- Internet connection status. (Connected/disconnected)

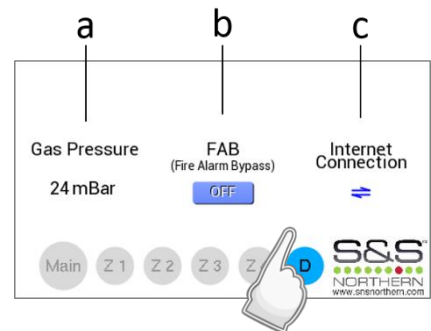

Fire Alarm Bypass

The fire alarm bypass (FAB) feature can be enabled at times where fire alarm tests are required. To enable the FAB feature select the Diagnostic screen and press the OFF/ON button shown where you are prompted to confirm the action prior to activation.

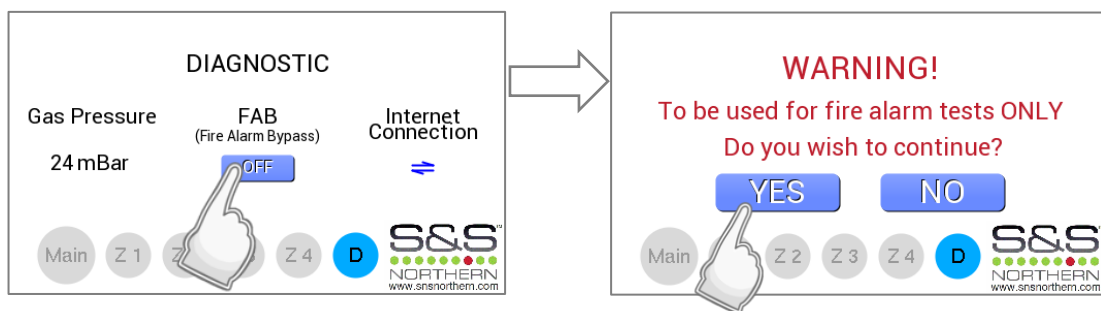

The FAB feature will be shown on screen when enabled and timeout at the end of the pre-selected time of 15, 30 or 45 minutes (see settings). You can manually disable the FAB by pressing the blue option box to OFF on the diagnostic screen.

Alarm Messages

The GDPX+ will display messages when in alarm – the messages are prompted from external devices that have been connected i.e. heat or pressure sensor.

When the GDPX+ goes in to alarm, the user can silence the audible buzzer by pressing MUTE.

During the alarm, the gas will be shut off and no gas detection details will be available.

After the cause of alarm has been rectified – press the RESET button on the GDPX+ panel.



The cause of alarm will have to be investigated and rectified before resetting the GDPX+.

Alarm Message List



EMERGENCY SHUT OFF

An emergency shut-off button has been activated.
Pressing MUTE on the GDPX+ will silence the audible alarm buzzer.
Investigate and rectify the issue before RESETTING the panel.



FIRE PANEL ALARM

The fire alarm panel has reached alarm status.
Pressing MUTE on the GDPX+ will silence the audible alarm buzzer.
Investigate and rectify the issue before RESETTING the panel.



HEAT SENSOR ALARM

Heat sensor/ thermal link has reached alarm status.
Pressing MUTE on the GDPX+ will silence the audible alarm buzzer.
Investigate and rectify the issue before RESETTING the panel.



LOW PRESSURE (10 second alarm delay)

Pressure sensor has detected a gas leak or a drop in gas pressure (<12mbar). Pressing MUTE on the GDPX+ will silence the audible alarm buzzer. Investigate and rectify the issue before RESETTING the panel.



PROVING TEST FAIL

Gas proving has failed test at start up.
Pressing MUTE on the GDPX+ will silence the audible alarm buzzer.
Investigate and rectify the issue before RESETTING the panel.

INPUT 1 & INPUT 2

Alarm messages from terminals [INPUT 1] and [INPUT 2] will depend on the name selected in the settings menu.

For example, if **LPG, NG, CO** or **CO2** etc. is the selected name for either INPUT terminal you will see the relevant alarm message. All alarm messages will shut off gas supply.



Or, if **FAN** is the selected name for either INPUT terminal you will see;
Where FAN is selected, the alarm will have a 10 second delay.



Pressing MUTE on the GDPX+ will silence the audible alarm buzzer.
Investigate and rectify the issue before pressing RESET on the panel.







Servicing & General Maintenance

On the gas detector - a service message will intermittently flash every 30 seconds after one year of operation. The detector will still operate as intended but contact your supplier immediately.

When Merlin gas detector(s) display the service message – the GDPX+ panel will show [SERVICE] on the status screen.

The GDPX+ will still operate as intended and if any dangerous gas levels are detected, your GDPX+ will show the detector ID in alarm in the top left hand corner.

Detector Alarm ID: 9					MUTE
ZONE 3					
ID	Serial Number	Gas	Status	Value	
9	123456789103	CO	SERVICE	82 ppm	
10	123456789103	H	GOOD	0.4 LEL%	
11	123456789103	CO	Pre-Alarm	47 ppm	
12					--X--



It is recommended that detectors are inspected and serviced at least annually from the date of installation for optimum performance and protection.

- ✓ DO carefully remove any accumulated dust from the outer enclosure once a month.
- ✗ NEVER use detergents or solvents to clean your detectors – this may permanently or temporarily damage the gas sensing elements.
- ✗ NEVER spray lighter gas, paint or other aerosols near the detectors.
- ✗ NEVER paint the device. Paint will seal vents and may interfere with the device.



Avoid exposure of high concentrations of alcohol found in many products, this can damage, deteriorate or affect the gas detectors. For more information refer to your detector manual.

Bump Testing

What is Bump Testing?

Bump testing is a term used for checking a gas detector is functioning correctly by exposing it to the target gas. A known concentration of the target gas is applied to the device to trigger an alarm condition and ascertain the detector is working safely.

Why is it Important?

A detector may visually appear in good order, but its sensitivity can be inhibited by external factors such as, dust; humidity; temperature fluctuations; cleaning products; contaminants or sensor drift (ageing). All can cause a decline in sensitivity and eventual failure.

The aim of the bump test is to make sure a gas detector is working at its optimum by briefly exposing the unit to a known concentration of the target gas. The reading (if displayed) is compared to the actual content of gas present, as stated on the test gas cylinder and if the detector goes into alarm within an acceptable range of the actual concentration, usually within 10%, then it is working safely.

If the bump test results are not within the acceptable range, the gas detector must not be used until a full calibration has been conducted.

Bump testing has a number of benefits for the end user:

- Peace of mind that the system does actually detect the gas in question.
- Allows the site to practice safe operations in a similar manner to the fire system.
- Early indication of any issues.

How Often?

Regular bump tests are important to make sure the detector is able to detect a release of gas as early as possible. A bump test usually takes seconds (gas type dependant) and is often completed alongside a scheduled fire alarm test, however the frequency should be determined following a risk assessment by the end user.

Current British standards recommend that for new installations - it may be prudent to carry out a bump test frequently (perhaps weekly), following a successful initial period and as confidence grows in the installation concerned, the frequency could be reduced.

Remember, bump testing does not remove the need to have gas detectors inspected, calibrated and serviced periodically by a trained engineer. You should not attempt this yourself and should employ the services of a specialist company.

For more information on this, contact us.

IMPORTANT WARNING STATEMENTS

Please take the time to thoroughly read this user's guide which should be retained for future reference.

It is recommended that this device be commissioned upon installation and serviced at least annually.

Do not apply lighter gas or other aerosols to detectors – this will cause extreme damage to the gas sensing elements.

High concentrations of alcohol found in many products may damage, deteriorate or affect the gas sensing elements of the detectors – Avoid exposure near your devices.

This device is designed to detect the gas displayed on screen and in the designated zone area from any source of combustion or dangerous level. It is NOT designed to detect smoke, fire or other gases and should NOT be used as such.

This device provides early warning of the presence of gas, usually before a healthy adult would experience symptoms. This early warning is possible provided your alarm is located, installed and maintained as described in this guide.

Never ignore your device when in alarm. Actuation of your alarm indicates the presence of an error or significant issue that requires immediate attention.

This device requires a continual supply of electrical power – it will not work without power.

This device should not be used to substitute proper installation, use and/or maintenance of fuel burning appliances including appropriate ventilation and exhaust systems.

This device does not prevent dangerous gasses from occurring or accumulating.

This unit may not fully safeguard individuals with specific medical conditions. If in doubt, consult a doctor/physician.

Your product should reach you in perfect condition, if you suspect it is damaged, contact your supplier.

Manufacturer's Warranty

3 Year Manufacturer's Warranty

Warranty coverage:

The manufacturer warrants to the original consumer purchaser, that this product will be free of defects in material and workmanship for a period of three (3) years from date of purchase. The manufacturer's liability hereunder is limited to replacement of the product with repaired product at the discretion of the manufacture. This warranty is void if the product has been damaged by accident, unreasonable use, neglect, tampering or other causes not arising from defects in material or workmanship. This warranty extends to the original consumer purchaser of the product only.

Warranty disclaimers:

Any implied warranties arising out of this sale, including but not limited to the implied warranties of description, merchantability and intended operational purpose, are limited in duration to the above warranty period. In no event shall the manufacturer be liable for loss of use of this product or for any indirect, special, incidental or consequential damages, or costs, or expenses incurred by the consumer or any other user of this product, whether due to a breach of contract, negligence, strict liability in tort or otherwise. The manufacturer shall have no liability for any personal injury, property damage or any special, incidental, contingent or consequential damage of any kind resulting from gas leakage, fire or explosion. This warranty does not affect your statutory rights.

Warranty Performance:

During the above warranty period, your product will be replaced with a comparable product if the defective product is returned together with proof of purchase date. The replacement product will be in warranty for the remainder of the original warranty period or for six months – whichever is the greatest.



Information on waste disposal for consumers of electrical & electronic equipment.

When this product has reached the end of its life it must be treated as Waste Electrical & Electronics Equipment (WEEE). Any WEEE marked products must not be mixed with general household waste, but kept separate for the treatment, recovery and recycling of the materials used. Please contact your supplier or local authority for details of recycling schemes in your area.

NOTES

Installation Details

Please pass this manual to the system owner or system user.

Date of Installation:	
Installation Location:	
Organisation:	
Stamp/ Signature of the installer:	

Contact Us:

S&S Northern Head Office

Tel: +44(0) 1257 470 983

Fax: +44(0) 1257 471 937

www.snsnorthern.com

info@snsnorthern.com

South East Division

Tel: +44(0) 1702 291 725

Fax: +44(0) 1702 299 148

south@snsnorthern.com



S&S Northern is the owner of this document and reserves all rights of modification without prior notice.