

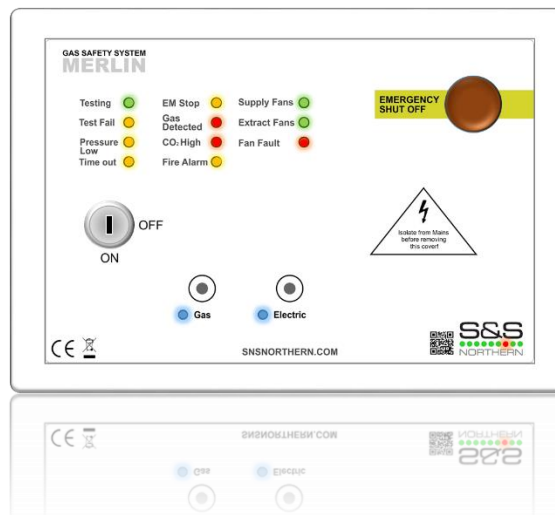

## Merlin 2000X+



## Installation & Operation Manual

Please read this manual carefully and retain for future use.

The Merlin 2000X+ is a gas proving, gas detection and electrical isolation controller with ventilation interlocking and current monitoring.

Information contained within this manual should be referenced for typical installation and operation only. For specific requirements that may deviate from the information in this guide – contact your supplier.

# Contents

<b>IMPORTANT WARNING STATEMENTS .....</b>	<b>3</b>
<b>INSTALLATION.....</b>	<b>4</b>
Planning .....	4
Mounting .....	4
Board Connections Diagram.....	5
Board Connections Overview .....	6
Access Configuration Settings .....	8
Configuration Settings Explained .....	8
Factory Set Condition .....	9
Fan Calibration.....	10
Fan Dropout Threshold Values .....	10
Specification.....	11
<b>OPERATION.....</b>	<b>12</b>
First Power Up .....	12
LED Indication Status.....	12
Utility Touch Buttons / LED Indication Status.....	13
System Diagnostics.....	14
General Maintenance.....	14
Installation Details.....	16



## IMPORTANT WARNING STATEMENTS

Please take the time to thoroughly read this user's guide which should be retained for future reference.

It is recommended that this device be commissioned upon installation.

Do not apply lighter gas or other aerosols to external gas detectors or monitors – this can cause extreme damage to the gas sensing elements.

High concentrations of alcohol found in many products may damage, deteriorate or affect the gas sensing elements of the detectors – Avoid exposure near your devices.

Never ignore your devices when in alarm. Actuation of your alarm indicates the presence of an error or issue that requires immediate attention.

This device requires a continual supply of electrical power – it will not work without power.

This device should not be used to substitute proper installation, use and/or maintenance of fuel burning appliances including appropriate ventilation and exhaust systems.

Your product should reach you in perfect condition, if you suspect it is damaged, contact your supplier.

---

### Manufacturer's Warranty

Warranty coverage:

The manufacturer warrants to the original consumer purchaser, that this product will be free of defects in material and workmanship for a period of three (3) years from date of purchase. The manufacturer's liability hereunder is limited to replacement of the product with repaired product at the discretion of the manufacturer. This warranty is void if the product has been damaged by accident, unreasonable use, neglect, tampering or other causes not arising from defects in material or workmanship. This warranty extends to the original consumer purchaser of the product only.

Warranty disclaimers:

Any implied warranties arising out of this sale, including but not limited to the implied warranties of description, merchantability and intended operational purpose, are limited in duration to the above warranty period. In no event shall the manufacturer be liable for loss of use of this product or for any indirect, special, incidental or consequential damages, or costs, or expenses incurred by the consumer or any other user of this product, whether due to a breach of contract, negligence, strict liability in tort or otherwise. The manufacturer shall have no liability for any personal injury, property damage or any special, incidental, contingent or consequential damage of any kind resulting from gas leakage, fire or explosion. This warranty does not affect your statutory rights.

Warranty Performance:

During the above warranty period, your product will be replaced with a comparable product if the defective product is returned together with proof of purchase date. The replacement product will be in warranty for the remainder of the original warranty period or for six months – whichever is the greatest.



### Information on waste disposal for consumers of electrical & electronic equipment.

When this product has reached the end of its life it must be treated as Waste Electrical & Electronics Equipment (WEEE).

Any WEEE marked products must not be mixed with general household waste, but kept separate for the treatment, recovery and recycling of the materials used. Please contact your supplier or local authority for details of recycling schemes in your area.

# INSTALLATION

## Planning

This panel can be used to carry out gas proving testing on pipe work to check if there is a gas appliance left open or potential gas leak. The Merlin 2000X+ is designed to give the user full control over incoming gas and electric supply with the lockable main key-switch and touch sensors. The panel can monitor gas levels in the air by connecting carbon dioxide, natural gas, carbon monoxide and LPG sensors. This model features a digital settings and diagnostic screen.

Selectable panel features include;

- ✓ Gas proving fill and prove time upon start up;
- ✓ Two optional pressure levels for failure of the proving test.
- ✓ Dual fan current monitoring from 0.1 to 18A;
- ✓ Automatic timeout;
- ✓ Connections to remote emergency shut off;
- ✓ Selectable utility emergency shut off;
- ✓ Fire Panel connection configuration;
- ✓ Building Management System integration;
- ✓ Fan calibration and current monitoring including diagnostics.



*Please refer to your detector manual for important information regarding coverage, location and positioning including areas and conditions to avoid!*

## Mounting

Unpack all the parts!

Placing the panel at eye level allows for optimum monitoring of LED Indicators.

1. Carefully remove the front cover from the unit by unscrewing the four bolts located at each corner. To do this – use the socket wrench provided.
2. Remove the power board from enclosure.
3. Mark the four screw holes located on the back of the enclosure to the wall. Ensure the wall surface is flat to prevent base distortion.
4. After executing the mounting and the connections – replace the front cover and insert the security caps over the four bolts.

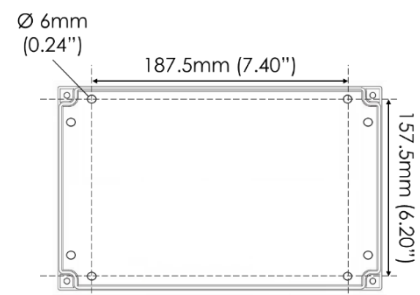

*Be careful when creating access for cables – Damage to boards will void any warranty!  
Any damage attempting to remove the circuit board parts may void any warranty!*

## Board Connections Diagram

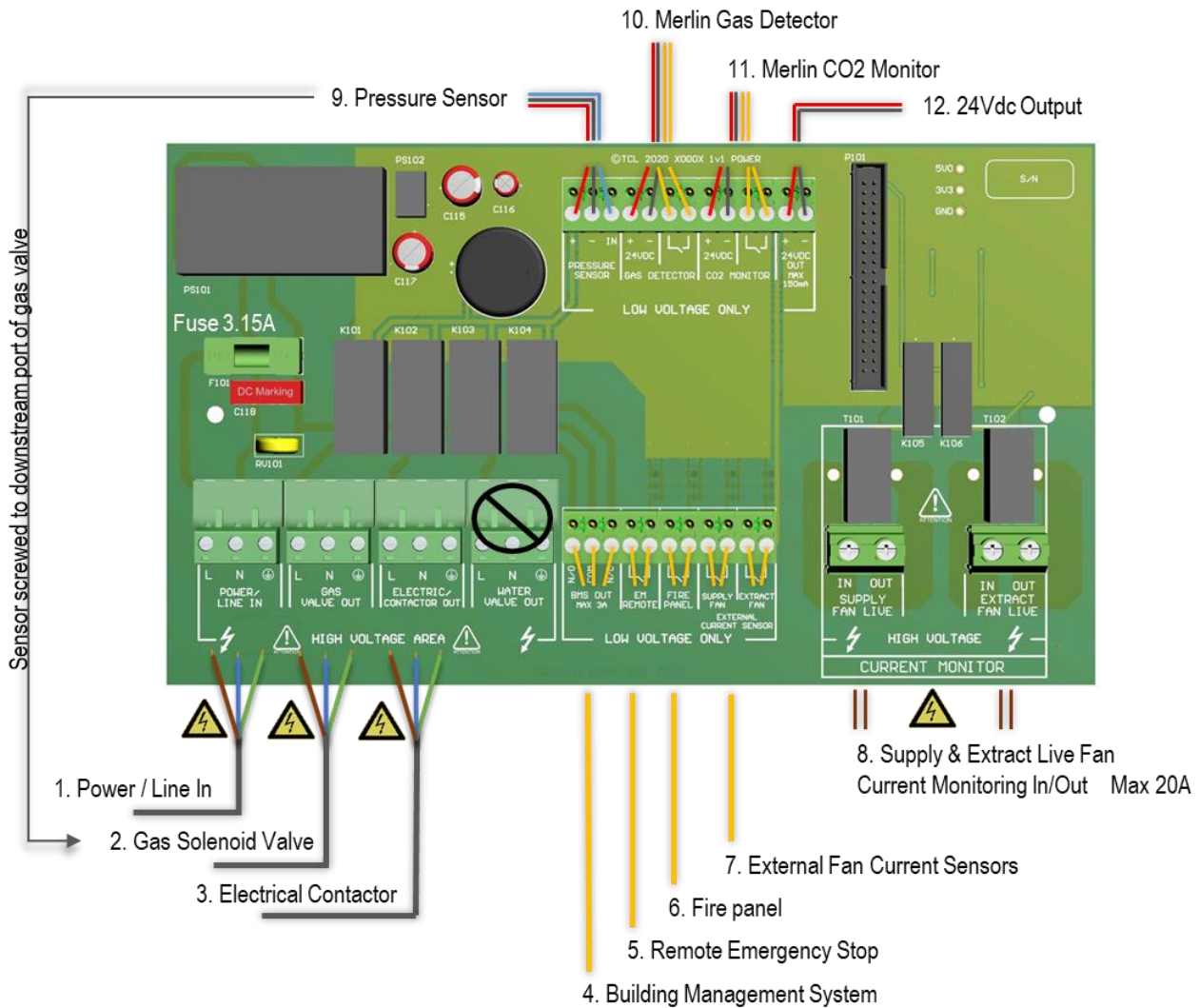

**⚠ WARNING!**

- To avoid electrical shock you must always isolate the mains supply before opening the panel!*
- Take care when making connections to high voltage connectors!*
- Avoid running mains wiring across the circuit board!*
- Any damage attempting to remove the circuit board may void any warranty!*
- Separate different circuits from each other by means of routing, clamping or barrier!*
- To avoid electrical interference, avoid installation near fan speed controllers!*

## Board Connections Overview

1. **POWER / LINE IN.** 100-240Vac electrical power should be supplied to the [POWER / LINE IN] terminal and fused at 3A.

On connecting the mains supply to the panel the power LED indicator will light up – this is located on the front cover (red dot of logo).

2. **GAS VALVE OUT.** 100-240Vac electrical power output is supplied from the [GAS VALVE OUT] terminal using a 3 core cable can be connected to a gas solenoid valve and isolate gas supply on alarm status. Pressure sensors should be screwed to the downstream port of the solenoid valve.

Refer to your valve manual for more information.

3. **ELECTRIC CONTACTOR OUT.** 100-240Vac electrical power output is supplied from the [ELECTRIC CONTACTOR OUT] terminal using a 3 core cable can be connected to a contactor and isolate electrics on alarm status.

Refer to your contactor manual for more information.

4. **BMS OUTPUT.** Connections are available on the board for Building Management Systems. This is a relay that changes state in alarm or when the gas is on/off. It can be used in conjunction with the 24Vdc output and other external relays that affect other devices and controls such as purge fans and audible alarms etc.

See section: *SETTINGS*- for BMS options.

5. **EM REMOTE.** Open/Close circuit connections for external devices is marked as [EM STOP] and can shut off utility supply when activated.

This is fitted with a factory link to represent a closed circuit.

6. **FIRE PANEL** The terminal for fire alarms is detailed on the circuit board as [FIRE PANEL] and can shut off utility supply when activated.

This is fitted with a factory link to represent a closed circuit.

7. **EXTERNAL FAN CURRENT SENSORS** These terminals are used to receive an input signal from external air pressure switches or external current monitors. These are linked out as a factory setting to represent a closed circuit.



*If only one fan is being used, the terminal not in use should be left closed!*

8. **CURRENT MONITOR** There are two terminals on the circuit board, one detailed as pictured [SUPPLY FAN LIVE] the other detailed [EXTRACT FAN LIVE].

The live feed from the fan controller should be connected to either the supply or extract side depending on which fan/s are being monitored.

Each will monitor its own independent fan.

From a fan controller the live feed should be taken to the [IN] terminal and the [OUT] terminal should wire to the fan motor controller.

Max 18A.

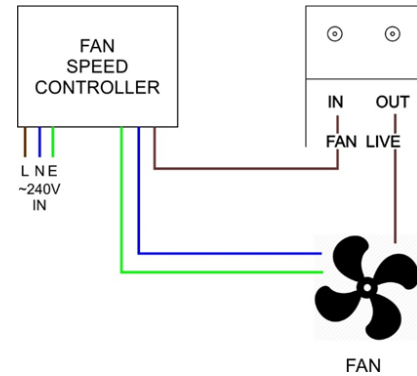

9. **PRESSURE SENSOR.** The sensor will monitor the gas supply pressure and if pressure drops below 12mbar – the gas valve will close as this could mean a gas leak is present.

Operating pressure: 0-100mbar.

Screw the sensor into the downstream port of the gas solenoid valve.

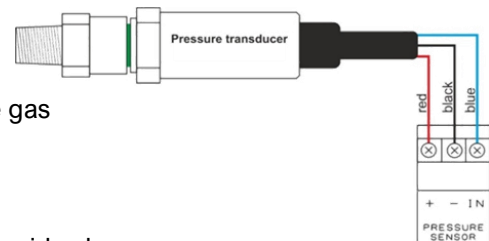

10. **GAS DETECTOR.** 24Vdc power can be supplied to a Merlin gas detector to shut off the system in the event of dangerous gas concentrations being detected. If no detector is being used leave the factory fitted link in.

Refer to your gas detector manual for further information.

11. **CO<sub>2</sub> MONITOR.** 24Vdc power can be supplied to a Merlin CO<sub>2</sub> monitor to shut off the system if high concentrations of CO<sub>2</sub> is detected.

Refer to your CO<sub>2</sub> monitor manual for further information.

12. **24V DC.** This is a permanent power output for external auxiliary devices when there is power supplied to the panel and can be used to create a relay switch with the BMS relay output.  
Max output: 150mA

## Access Configuration Settings

On the front fascia circuit board you'll find a [SETTINGS] dip-switch – when switched ON (before turning the panel on) via the key switch, the screen will display the settings menu – you can now configure your panel. To view, change and save settings, you must provide mains power.

There are four buttons, press to navigate through the settings and configure the system. To select functions and change options;

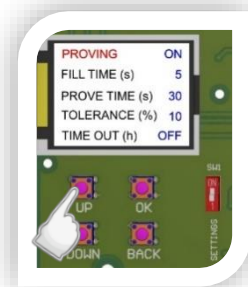

- navigate functions by pressing [UP] or [DOWN];
- press [OK] to select options;
- press [UP] or [DOWN] to change option setting;
- press [OK] to save option or [BACK] to return to function.



When changes have been made – turn the SETTINGS switch OFF and restart the key switch!

## Configuration Settings Explained

Page 1	Page 2	Page 3	Page 4	Page 5																																												
<table border="1" style="width: 100%; border-collapse: collapse;"> <tr><td>PROVING</td><td>ON</td></tr> <tr><td>FILL TIME (s)</td><td>5</td></tr> <tr><td>PROVE TIME (s)</td><td>30</td></tr> <tr><td>TOLERANCE (%)</td><td>10</td></tr> <tr><td>TIME OUT (h)</td><td>OFF</td></tr> </table>	PROVING	ON	FILL TIME (s)	5	PROVE TIME (s)	30	TOLERANCE (%)	10	TIME OUT (h)	OFF	<table border="1" style="width: 100%; border-collapse: collapse;"> <tr><td>EM SEL.</td><td>E OFF</td></tr> <tr><td>FP SEL.</td><td>E OFF</td></tr> <tr><td>BMS SEL.</td><td>GAS ON</td></tr> <tr><td>GAS D.SEL.</td><td>G&amp;E OFF</td></tr> <tr><td>CO2 M.SEL.</td><td>G&amp;E OFF</td></tr> </table>	EM SEL.	E OFF	FP SEL.	E OFF	BMS SEL.	GAS ON	GAS D.SEL.	G&E OFF	CO2 M.SEL.	G&E OFF	<table border="1" style="width: 100%; border-collapse: collapse;"> <tr><td>GEW BUTTONS(s)</td><td>10</td></tr> <tr><td>ELEC. VENT.</td><td>OFF</td></tr> <tr><td>FACTORY RESET</td><td></td></tr> </table>	GEW BUTTONS(s)	10	ELEC. VENT.	OFF	FACTORY RESET		<table border="1" style="width: 100%; border-collapse: collapse;"> <tr><td>FAN'S CM.</td><td>OFF</td></tr> <tr><td>FAN'S CALIB.</td><td>-</td></tr> <tr><td>FAN'S THRESHOLD</td><td></td></tr> <tr><td>FAN'S CALIB. RESET</td><td></td></tr> </table>	FAN'S CM.	OFF	FAN'S CALIB.	-	FAN'S THRESHOLD		FAN'S CALIB. RESET		<table border="1" style="width: 100%; border-collapse: collapse;"> <tr><td>THRESHOLD</td><td>[%]</td></tr> <tr><td>SUPPLY MIN.</td><td>10</td></tr> <tr><td>SUPPLY MAX.</td><td>10</td></tr> <tr><td>EXTRACT MIN.</td><td>10</td></tr> <tr><td>EXTRACT MAX.</td><td>10</td></tr> </table>	THRESHOLD	[%]	SUPPLY MIN.	10	SUPPLY MAX.	10	EXTRACT MIN.	10	EXTRACT MAX.	10
PROVING	ON																																															
FILL TIME (s)	5																																															
PROVE TIME (s)	30																																															
TOLERANCE (%)	10																																															
TIME OUT (h)	OFF																																															
EM SEL.	E OFF																																															
FP SEL.	E OFF																																															
BMS SEL.	GAS ON																																															
GAS D.SEL.	G&E OFF																																															
CO2 M.SEL.	G&E OFF																																															
GEW BUTTONS(s)	10																																															
ELEC. VENT.	OFF																																															
FACTORY RESET																																																
FAN'S CM.	OFF																																															
FAN'S CALIB.	-																																															
FAN'S THRESHOLD																																																
FAN'S CALIB. RESET																																																
THRESHOLD	[%]																																															
SUPPLY MIN.	10																																															
SUPPLY MAX.	10																																															
EXTRACT MIN.	10																																															
EXTRACT MAX.	10																																															

FUNCTION	OPTION	Explanation
PROVING	- OFF - ON	Enable/disable gas pressure proving upon system start up/reset to check the gas line for leaks. See section: LED status.
FILL TIME (S)	- 5 - 10	Time (seconds) the gas valve is open to fill gas line for proving. Proving must be switched on.
PROVE TIME (S)	- 30 - 50	Time (seconds) the panel tests the gas line for leaks. Proving must be switched ON.
TOLERANCE (%)	- 10 - 15	Percentage drop in pressure for failure of the gas proving test. (10% or <12mbar). Proving must be switched ON.
TIMEOUT (H)	- OFF - 1-12	Time (hours) that the system will automatically shut down all utility supply. Select OFF or from 1 to 12 hours.
EM SEL.	- E OFF - E ON	Activation of shut off buttons (gas supply isolated automatically). <ul style="list-style-type: none"> <li>• E OFF isolate Electrical supply</li> <li>• E ON Electric supply remain active</li> </ul>
FP SEL.	- E OFF - E ON	Activation of a fire alarm (gas supply isolated automatically). <ul style="list-style-type: none"> <li>• E OFF isolate Electrical supply</li> <li>• E ON Electric supply remain active</li> </ul>
BMS SEL.	- GAS ON - ERROR - KEY SW.	<ul style="list-style-type: none"> <li>• GAS ON signals the BMS when gas is supplied or not only.</li> <li>• ERROR signals the BMS on an error condition i.e. gas levels, etc.</li> <li>• KEY SW. BMS follow by key switch ON/OFF status only.</li> </ul>
GAS D. SEL.	- G&E OFF - G ON - E ON	Activation of the connected gas detector alarm will: <ul style="list-style-type: none"> <li>• G&amp;E OFF isolate the Gas and Electrical supply</li> <li>• G ON isolate Electrics only</li> <li>• E ON isolate Gas only</li> </ul>



CO2 M. SEL.	- G&E OFF - G ON - E ON	Activation of the connected CO2 monitor alarm will: <ul style="list-style-type: none"> <li>• <b>G&amp;E OFF</b> isolate the Gas and Electrical supply</li> <li>• <b>G ON</b> isolate Electrics only</li> <li>• <b>E ON</b> isolate Gas only</li> </ul>
GEW BUTTONS (S)	- 10 - ON	Gas and Electric (GE) touch buttons on the panel will be active for 10 seconds to enable supply when key switch is turned ON or be set permanently ON and active anytime. See section: First Power Up.
ELEC. VENT.	- OFF - ON	Ventilation interlocking can be checked before the electric relay is energised. The electric relay will also be de-energised if a fan fault is present. This option can be enabled ON or disabled OFF.
FACTORY RESET	- NO - YES	Return to factory set condition. See Section: Factory Set Condition
FANS CM.	- OFF - ON - SUP ONLY - EXT ONLY	Combination of fan current monitoring. Select either current monitoring OFF, current monitoring for both Supply and Extract (ON) or either Supply or Extract only.
FANS CALIB.	- - OK	If fans are calibrated, this will be set as 'OK'. See section: Fan Calibration to calibrate fans.
FANS THRESHOLD %	- 10 - 20 - 30 - 40	Dropout threshold for Min and Max current values of both supply and extraction fans. It is possible to select between a 10% to a 40% dropout threshold if required. You will need to recalibrate fans after changing dropout thresholds. See section: Fan Dropout Threshold Values.
FANS CALIB. RESET	- NO - YES	Remove and reset any saved fan calibration settings. See Section: Factory Set Condition

### Factory Set Condition

<b>PROVING</b> ON	EM SEL. E OFF	GEW BUTTONS(s) 10	FAN'S CM. OFF	THRESHOLD [%]
FILL TIME (s) 5	FP SEL. E OFF	ELEC. VENT. OFF	FAN'S CALIB. -	SUPPLY MIN. 10
PROVE TIME (s) 30	BMS SEL. GAS ON		FAN'S THRESHOLD	SUPPLY MAX. 10
TOLERANCE (%) 10	GAS D.SEL. G&E OFF		FAN'S CALIB. RESET	EXTRACT MIN. 10
TIME OUT (h) OFF	CO2 M.SEL. G&E OFF	FACTORY RESET		EXTRACT MAX. 10

## Fan Calibration

Select **[FANS CALIB.]** In the settings menu.

1. Press [OK] to switch to supply (SUPP.) or extraction (EXTR.) fan.  
Fan selection highlighted yellow.
2. Wait for the current value to appear (A).
3. Press [UP] button to calibrate highest fan current.  
If successful, 'OK' appears on screen (MAX.)
4. Press [DOWN] button to calibrate low fan current.  
If successful, 'OK' appears on screen (MIN.)  
Fan icons switch from black to green.

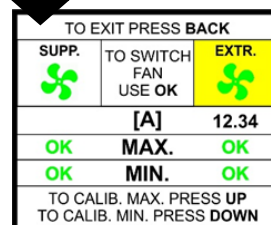
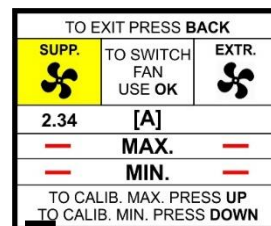

*If calibration is unsuccessful then alter fan dropout thresholds in the settings menu and repeat.*

## Fan Dropout Threshold Values

When **[FANS THRESHOLD]** is selected in the settings menu, the user can adjust the minimum and maximum current values by 10, 20, 30 or 40%.

For fans with a current <0.1A we recommend a dropout threshold ≥ 30%.

THRESHOLD	[%]
SUPPLY MIN.	10
SUPPLY MAX.	10
EXTRACT MIN.	10
EXTRACT MAX.	10

Threshold value (%)	10	20	30	40
Running current (Max.)	18A	16.5A	15A	14A

The 2000X+ can display fan currents (amp) and gas pressure (mbar) in the diagnostic screen.

See section: Diagnostics



*If calibration is successful it is possible to change the fan threshold without recalibration!  
Fans new threshold automatically recalculates min and max current fan fault values!*

**Specification**

Model:	2000X+
Display	1.8" Screen TFT (located inside)
Power Input Voltage	100-240Vac
Gas Valve Output Voltage	100-240Vac
Electrical Contactor Output Voltage	100-240Vac
BMS Max Output	3A
Single phase AC current monitor calibration range	0.1 – 18 Amps
Single phase AC current monitor display	0 - 22Amps
Power Consumption	4.7 W (Panel), 20W max (fully loaded)
Internal Fuse	3.15A
Operating Temperature	0 – 50°C (32 – 122°F) 30-85%RH Non-Condensing
Audible Alarm Buzzer dB	65 dB (300mm distance in quiet conditions)
Pressure Sensor Operating Pressure	0 - 100mbar
O/All Dimensions (H x W x D) mm	180 x 255 x 77mm

# OPERATION

## First Power Up

1. Supply mains power, the red LED on the front of the panel will illuminate (dot on logo).
2. Turn fans on.
3. Turn the key switch to on position.
4. \*\*Gas & Electric service LEDs will flash for 10 seconds.
5. \*\*Press relevant service button to turn required utility on.
6. \*\*The panel will check the integrity of the gas line for leaks.

\*\*Factory set condition.



All services can be turned on or off within 10 seconds of the key switch being on and panel powered up. After 10 seconds, all utility buttons will be disabled. The user must turn the key off and back on to adjust services. (This can be changed to permanently available in settings).

## LED Indication Status

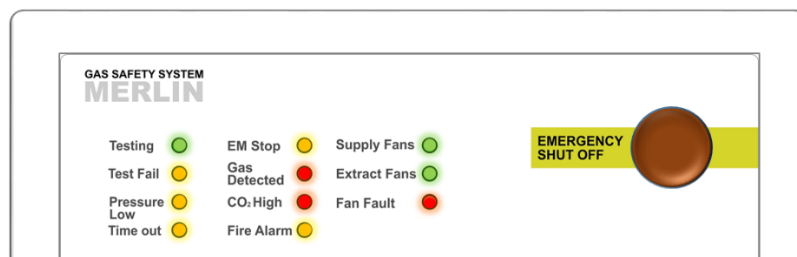

- **Testing**  
This LED will illuminate for approximately 30 seconds when the panel is checking the integrity of the gas installation upon start up. Do not operate appliances while this is on.
- **Test Fail**  
Under normal working conditions this LED is off. If the panel detects an issue with the gas supply upon start-up this LED will illuminate and the gas valve will remain closed.
- **Pressure Low**  
Under normal working conditions this LED is off. The LED will illuminate when pressure of the gas supply drops below 12mbar for 10 secs or more and the gas valve will close.
- **Timeout**  
This LED will illuminate if automatic shut-down has occurred following defined timer.
- **EM Stop**  
If an emergency shut off button (either remote or on the panel) is pressed, the LED will illuminate and the gas supply will be isolated. Electrical supply will also isolate if the panel is configured to do so. Any shut-off buttons must be reset before restarting the system.
- **Gas Detected**  
If an external Merlin detector connected detects dangerous gas levels this LED will illuminate and the gas supply is isolated. Electrical supply will also isolate if the panel is configured to do so.

- **CO<sub>2</sub> High**  
If the concentration of CO<sub>2</sub> in the air is at alarm level (relevant detector required), the LED will illuminate and the gas supply is isolated. Electrical supply will also isolate if the panel is configured to do so.
- **Fire Alarm**  
If the fire panel connected detects a fire the LED will illuminate and the gas is isolated. Electrical supply will also isolate if the panel is configured to do so.
- **Supply Fan - Under normal working conditions this LED is on.**  
If a supply fan external current sensor fault is detected, the LED will flash.  
After ~20 seconds: the LED will remain on and Fan Fault LED will illuminate.  
If a supply fan internal current monitor fault is detected, the LED will flash.  
After ~20 seconds the LED will flash twice a second and Fan Fault LED will illuminate.
- **Extract Fan - Under normal working conditions this LED is on.**  
If an extract fan external current sensor fault is detected, the LED will flash.  
After ~20 seconds: the LED will remain on and Fan Fault LED will illuminate.  
If an extract fan internal current monitor fault is detected, the LED will flash.  
After ~20 seconds the LED will flash twice a second and Fan Fault LED will illuminate.
- **Fan Fault**  
If a fan fault occurs for longer than 20 seconds, the LED will illuminate RED.

## Utility Touch Buttons / LED Indication Status

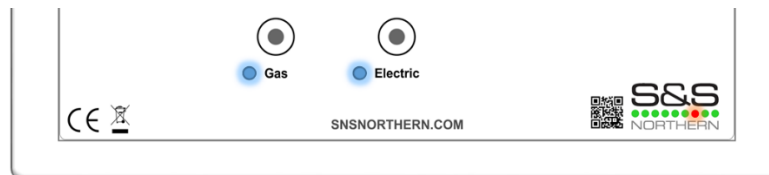

- **Gas** - When the key switch is turned on, the system will check the installation for gas leaks.  
\*\*If gas proving is successful, the Testing LED will turn off and this Gas LED will remain ON.
- **Electric** - If Electrical supply utility is turned on, the Electric LED will illuminate.  
ON = Electric On  
OFF = Electrics Off, Electric button disabled.

\*\*Factory Set Condition.

Gas LED will flash when checking external current sensors, current monitor or gas proving.  
Electric LED will flash when checking external current sensors or current monitor.

## System Diagnostics



**WARNING!** Contact with mains electrical power can be fatal!

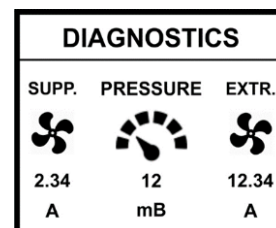

The panel can display fan current (Amps) and gas pressure (mbar).

To view these diagnostics, carefully remove the front fascia of the panel, to activate screen diagnostics, press either the [OK], [UP] or [DOWN] button. The diagnostic screen is available during; proving status; normal operation; fan fault and pressure low status. The screen will automatically enter sleep mode after 10 minutes of inactivity or when the [BACK] button pressed.

**L** = fan current is less than the minimum calibrated value.

**H** = fan current is greater than the maximum calibrated value.

Gas pressure is low

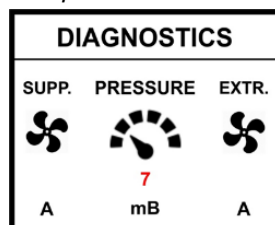

Current higher than calibrated value.

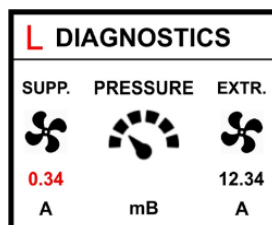

Current less than calibrated value.

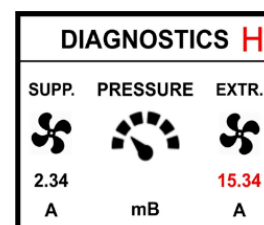

## General Maintenance

Keep your system in good working order follow these basic principles;

- Remove any dust/debris from the outer enclosure regularly using a slightly damp cloth.
- Never use detergents or solvents to clean your gas detection devices.
- Never spray air fresheners, hair spray, paint or other aerosols near devices.
- Never paint devices. Paint will seal vents and interfere with the device.



*It is recommended that detectors are inspected and serviced at least annually from the date of installation for optimum performance and protection due to sensitivity drifts!*



*High concentrations of alcohol found in many products may damage, deteriorate or affect the gas sensor such as; wine; deodorants; stain removers; thinners etc. Other gases and substances to avoid are; Corrosives (i.e. chlorine & hydrogen chloride); Alkali metals; Basic or acidic compounds; Silicones; Tetraethyl lead; Halogens and halogenated compounds!*

## ENGINEERING NOTES - Blank

## Installation Details

Please pass this manual to the system owner or system user.

Date of Installation:	
Installation Location:	
Organisation:	
Stamp/ Signature of the installer:	

### S&S Northern Head Office

Tel: +44(0) 1257 470 983  
Fax: +44(0) 1257 471 937  
[www.snsnorthern.com](http://www.snsnorthern.com)  
[info@snsnorthern.com](mailto:info@snsnorthern.com)

### South East Division

Tel: +44(0) 1702 291 725  
Fax: +44(0) 1702 299 148  
[south@snsnorthern.com](mailto:south@snsnorthern.com)



S&S Northern is the owner of this document and reserves all rights of modification without prior notice.