

Mini Merlin



LPGCO Dual Gas Controller



INSTALLATION & OPERATION INSTRUCTIONS

Please read these instructions carefully and retain for future use.

These instructions can be downloaded in electronic form on the product website.























S&S Northern Limited

snsnorthern.com

Contents

Safety Information	3
Carbon Monoxide – General Information	4
LPG – General Information	4
Installation	5
Typical Application & Location	5
Mounting & Cabling	6
Circuit Board Overview	7
Wiring – Gas Solenoid Valve	7
Wiring – Appliance Limit Circuits	8
Wiring – Remote Shut Off	8
Auto Reset & Buzzer Switches	8
Building Management System	9
Operation	9
Initial Power Up	9
Digital Indications	9
Alarm Set Points	9
Alarm Reset	10
Remote Shut Off Indication	10
Manual Circuit Simulation Test	10
End of Operational Life (EOL)	10
Maintenance	11
Cleaning	11
Manual Circuit Simulation Test	11
Bump Test (Gas Response Check)	11
Bump Test Procedure	12
Specification	15

Safety Information

-  Before any installation, use or maintenance read this manual carefully.
-  The information contained within this manual should be referenced for typical installation and operation only.
-  For site specific requirements that may deviate from the information in this guide – contact your supplier.
-  If this product is used in a manner not specified by the manufacturer, the safety provided by the product may be impaired.
-  This product is designed for indoor operation only.
-  Detectors and cables must be protected against mechanical damage.
-  The internal fuse should be replaced only with the same type. Anti-surge fuse 3.15A 250Vac 5x20.
-  The expected lifetime of gas sensor elements is 5 years upon initial power up. The device will display a message to indicate this time and should immediately be replaced.
-  It is recommended that this product be commissioned upon installation and serviced annually.
-  Do not apply lighter gas or other aerosols to the product – this will cause extreme damage.
-  High concentrations of alcohol / ethanol found in many products may damage, deteriorate, or affect the gas sensing elements – Avoid exposure near your device.
-  This equipment is designed to detect carbon monoxide and natural gas only - from any source of combustion.
-  This product is not designed to detect smoke, fire or other gases and should NOT be used as such.
-  This device provides early warning of the presence of LPG or carbon monoxide, usually before a healthy adult would experience symptoms. This early warning is possible provided your alarm is located, installed and maintained as described in this guide.
-  This device requires a continual supply of electrical power – it will not work without power.
-  This device should not be used to substitute proper installation, use and / or maintenance of fuel burning appliances including appropriate ventilation and exhaust systems.
-  This device does not prevent LPG or carbon monoxide from occurring or accumulating.
-  Actuation of your alarm indicates the presence of dangerous levels of LPG or CO.
-  The device can respond to other gases other than its intended target such as Hydrogen (H₂), Ethylene (C₂H₄) and Nitric Oxide (NO). In addition, the LPG sensor may react to iso-butane.
-  Seek fresh air supply and contact your local gas emergency service should you suspect a gas leak.
-  This device may not fully safeguard individuals with specific medical conditions.
-  If in doubt, consult a doctor / physician.
-  Your product should reach you in perfect condition, if you suspect it is damaged, contact your supplier.

Warranty Statement

Warranty Coverage: The manufacturer warrants to the original consumer purchaser, that this product will be free of defects in material and workmanship for a period of two (2) years from date of purchase.

The manufacturer's liability hereunder is limited to replacement of the product with repaired product at the discretion of the manufacturer. This warranty is void if the product has been damaged by accident, unreasonable use, neglect, tampering or other causes not arising from defects in material or workmanship. This warranty extends to the original consumer purchaser of the product only. Disclaimers: Any implied warranties arising out of this sale, including but not limited to the implied warranties of description, merchantability and intended operational purpose, are limited in duration to the above warranty period. In no event shall the manufacturer be liable for loss of use of this product or for any indirect, special, incidental or consequential damages, or costs, or expenses incurred by the consumer or any other user of this product, whether due to a breach of contract, negligence, strict liability in tort or otherwise. The manufacturer shall have no liability for any personal injury, property damage or any special, incidental, contingent or consequential damage of any kind resulting from gas leakage, fire or explosion. This warranty does not affect your statutory rights. Performance: During the above warranty period, your product will be replaced with a comparable product if the defective product is returned together with proof of purchase date. The replacement product will be in warranty for the remainder of the original warranty period or for six months – whichever is the greatest.

Information on waste disposal for consumers of electrical & electronic equipment.



When this product reaches the end of its life it must be treated as Waste Electrical & Electronics Equipment (WEEE).

WEEE marked products must not be mixed with general household waste, but kept separate for the treatment, recovery and recycling of the materials used. Please contact your supplier or local authority for details of recycling schemes in your area.

At the end of their working life, electrochemical sensors should be disposed of in an environmentally safe manner. Alternatively, they can be securely packaged and returned to S&S clearly marked for disposal. Electrochemical sensors should not be incinerated as this may cause the cell to emit toxic fumes.

Carbon Monoxide – General Information

Carbon monoxide (CO) is a poisonous, colourless, odourless, and tasteless gas. Although it has no detectable odour, CO is often mixed with other gases that do have an odour. So, you can inhale carbon monoxide right along with gases that you can smell and not be aware that CO is present.

SYMPTOMS OF CARBON MONOXIDE GAS POISONING

The following symptoms are related to CO poisoning and should be discussed with all members of the household, facility, or person(s) frequenting monitored areas.

- Mild Exposure: Slight headache, nausea, vomiting, fatigue, flu-like symptoms.
- Medium Exposure: Severe headache, drowsiness, confusion, increased heart rate.
- Extreme Exposure: Unconsciousness, convulsions, cardio-respiratory failure, death.

CARBON MONOXIDE GAS LEVELS

This product is equipped with a digital display that shows levels of CO displayed in PPM (parts per million). See the specification table for how this product monitors Carbon Monoxide gas.

POSSIBLE SOURCES OF CARBON MONOXIDE GAS

Inside your home or facility, gas appliances used for heating, water heating and cooking are the most likely sources of CO. Vehicles running in attached garages can also produce dangerous levels of CO.

CO can be produced when burning any fossil fuel, such as gasoline, propane, natural gas, oil and wood. It can be produced in any fuel burning appliance that is malfunctioning, improperly installed or insufficiently ventilated.

- Automobiles, gas stoves, water heaters, portable fuel burning heaters, fireplaces.
- Blocked chimneys or flues corroded or disconnected vent pipes.
- Burning charcoal or fuel in grills in an enclosed area or near the home.

LPG – General Information

Liquefied petroleum gas or liquid petroleum gas – (LPG), are constituents of propane and butane, both flammable hydrocarbon fuel gases used for heating, cooking, and vehicles. It is.

- Obtained during the processing of crude oil, or direct from the sea.
- Colourless and odourless. An odourising agent is added before distribution.
- Half as heavy as water when in liquid form. It will float on water before vaporising.
- Either commercial butane or commercial propane - similar in use but propane has a lower boiling point and hence a higher storage pressure. Commercial propane is predominantly an outdoor fuel, commercial butane is predominantly an indoor fuel.

HOW IS LPG COMMONLY USED?

LPG is used in your home, including cooking, heating, hot water, Autogas, aerosol propellant, air-conditioning refrigerant, and back-up generator applications. LPG used in your home is typically supplied in 45kg LPG gas bottles and commonly used for BBQ's and camping.

Business and industry use LPG fuel for a multitude of processes including steam boilers, kilns, ovens, and LPG forklifts.







WHAT ARE THE HAZARDS OF LPG?

- LPG is approximately twice as heavy as air when in gas form and will tend to sink to the lowest possible level and may accumulate in cellars, pits, drains etc.
- LPG in liquid form can cause severe cold burns to the skin owing to its rapid vaporisation.
- Vaporisation can cool equipment so that it may be cold enough to cause cold burns.
- LPG forms a flammable mixture with air in concentrations of between 2% and 10%. Your device is designed to warn you at 0.16% concentration BV (by volume of air) and will alarm at 0.2% BV – this is 8% & 10% of the Lower Explosive Limit (LEL).
- Vapour /air mixtures arising from leakages may be ignited some distance from the point of escape and the flame can travel back to the source of the leak.
- At very high concentrations when mixed with air, vapour is an anaesthetic and can subsequently asphyxiate by diluting the available oxygen.
- A vessel that has contained LPG is nominally empty but may still contain LPG vapour and be potentially dangerous. Therefore, treat all LPG vessels as if they were full.

For more information, please visit our website or contact us.

Installation

Typical Application & Location

-  **Installation must be in accordance with the recognised standards of the appropriate authority in the country concerned!**
-  **Access to the interior of the device, when carrying out any work, must only be conducted by trained personnel!**
-  **Before carrying out any work ensure local regulations and site procedures are followed!**
-  **Easy access is recommended for both status observation and alarm purposes and must be located out of reach of the public!**
-  **Isolate the equipment from all hazardous live power sources before opening the cover!**
-  **Avoid conditions of any other environmental factors outside of the specification that could potentially impede the accuracy and operation of the detector such as condensation; vibration; temperature, pressure, the presence of other gases, electromagnetic interference, and draft zones!**

Your new Mini Merlin is a dual gas detector carefully designed to monitor levels of Liquid Petroleum Gas (LPG) and Carbon Monoxide (CO) in the air. If there is a dangerous build-up of target gas at the sensor, this device can shut off the gas supply via a gas safety valve and /or gas fired appliance(s). This device has additional features for resetting systems, as well as audible and visual alarms and can also be integrated with a Building Management System (BMS).

Your detector should be installed in areas at risk of gas leaks e.g., over boilers, valves, or meters. Located in positions determined by those who have knowledge of gas dispersion, the process plant system and equipment involved, and in consultation with both safety and electrical engineering personnel.

Take in to account the design of the air flow patterns within the zone area. Detectors should be installed in the correct orientation, as recommended by the manufacturer, and ease of access should be accounted for to allow for any bump tests and other forms of maintenance throughout its operating life.

There are no official figures of the area coverage of a gas detector; however, 50-100m² per detector is a reasonable general guide therefore consider multiple detectors may be required to adequately protect property and persons. The target gas will only be identified when contact is made with the sensing element itself.

Recommended heights may vary based on air flow and temperature conditions in addition to the proposed application and location. The device should be mounted near the boiler or gas fired appliances such as domestic & commercial boiler rooms and basements.

As a guide only we recommend the following:

- 6ft from sources of combustion e.g., boiler s/ heaters / gas fired appliances etc.
- 4ft from draft zones and ventilation areas e.g., windows, doorways, and a/c units etc.
- 5ft from ground level.

There are no specific standards governing gas detector location (unlike fire detection systems); there are, however, general guidance documents. The most relevant being *IEC 600-79-29-2: Explosive Atmospheres – Part 29: Gas detectors – Selection, installation, use and maintenance of detectors for flammable gases and oxygen*. Much of what it covers is also relevant to toxic gas detection.

Mounting & Cabling

- ⚠ If mounting direct to wall - ensure the wall surface is flat to prevent base distortion!
- ⚠ Ensure the rear base is installed in the correct orientation as shown!
- ⚠ Where cable glands/conduits are used for wire entry, use 20mm (3/4 inch) max separated by at least 20mm!
- ⚠ Any parts that form part of the connections/installation must have a minimum fire retardant rating of UL94V-1!
- ⚠ Damage to PCBs when creating cable entry points or attempting to remove the circuit board may void any warranty!
- ⚠ The monitor is designed for either surface mounting or mounted on a one or two gang electrical box.
- ⚠ Restrain the hazardous live wiring from accidental loosening to prevent wires from moving after installation and touching parts of opposite polarity or at low voltages!
- ⚠ Isolate the equipment from all hazardous live power sources before opening the cover!

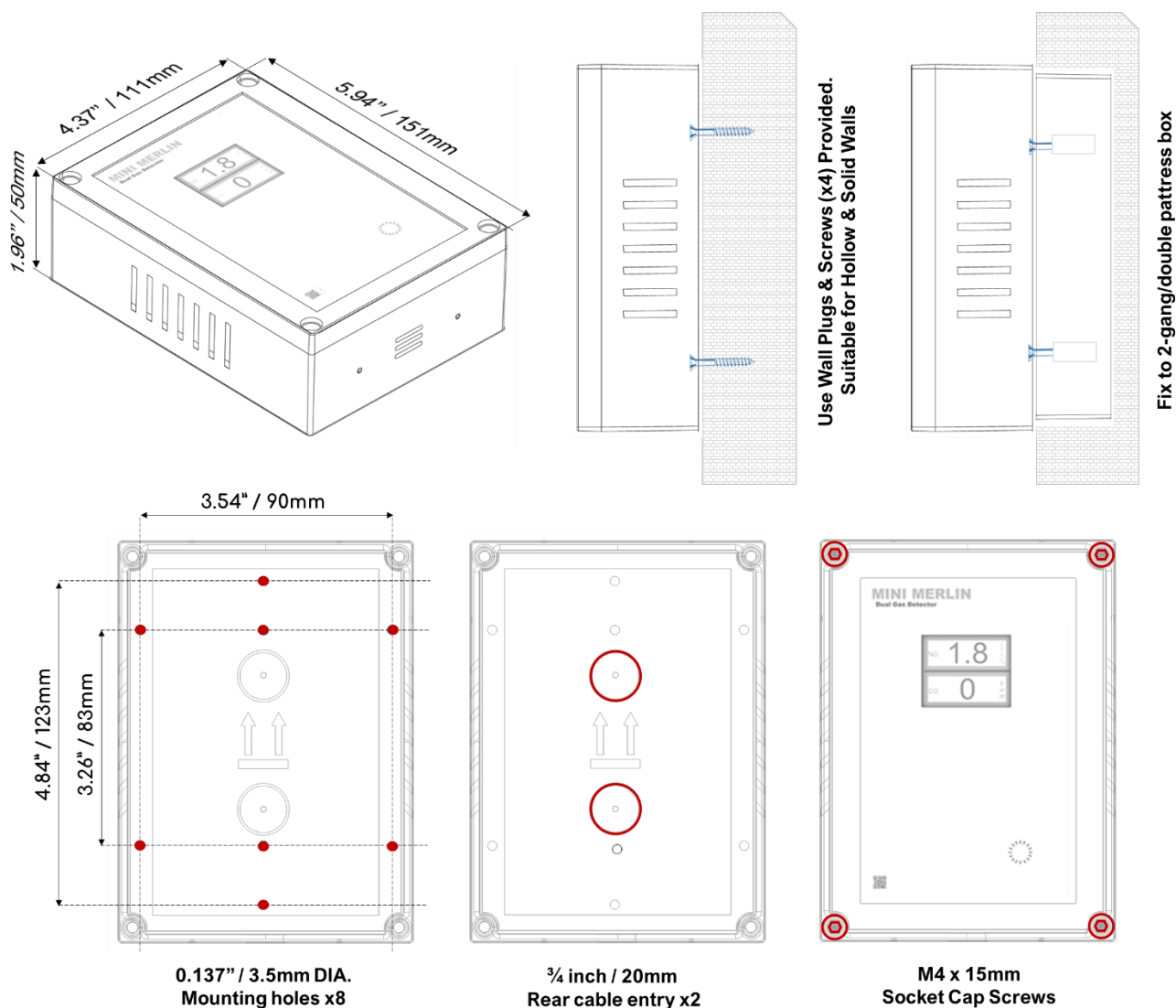

1. Carefully remove the front cover from the unit by using an M3 socket wrench.
2. Using the rear base - mark mounting holes to the wall or align with an appropriate gang/pattress box.
3. Fixing straight to wall – drill 0.2" (5mm) hole, insert plugs and use the four screws (No.4 Pozi) provided.
4. There are pre-fractured areas for cable entry on the rear of the base and pilot holes positioned on the top and bottom of the enclosure suitable for entry points up to 3/4" (20mm).
5. After executing the mounting/connections – secure the front cover with all M4 bolts and insert security caps provided.

Circuit Board Overview

- ⚠ **Damage to PCBs when creating cable entry points may void any warranty!**
- ⚠ **Take care when making connections to high voltage connectors!**
- ⚠ **Any damage attempting to remove the circuit board may void any warranty!**
- ⚠ **All Class 2 wiring is to be installed within flexible tubing to maintain segregation between circuits!**
- ⚠ **Wiring of different circuits shall be separated by means of routing, clamping or barrier!**
- ⚠ **For field connections use wires suitable for at least 167°F (75°C)**

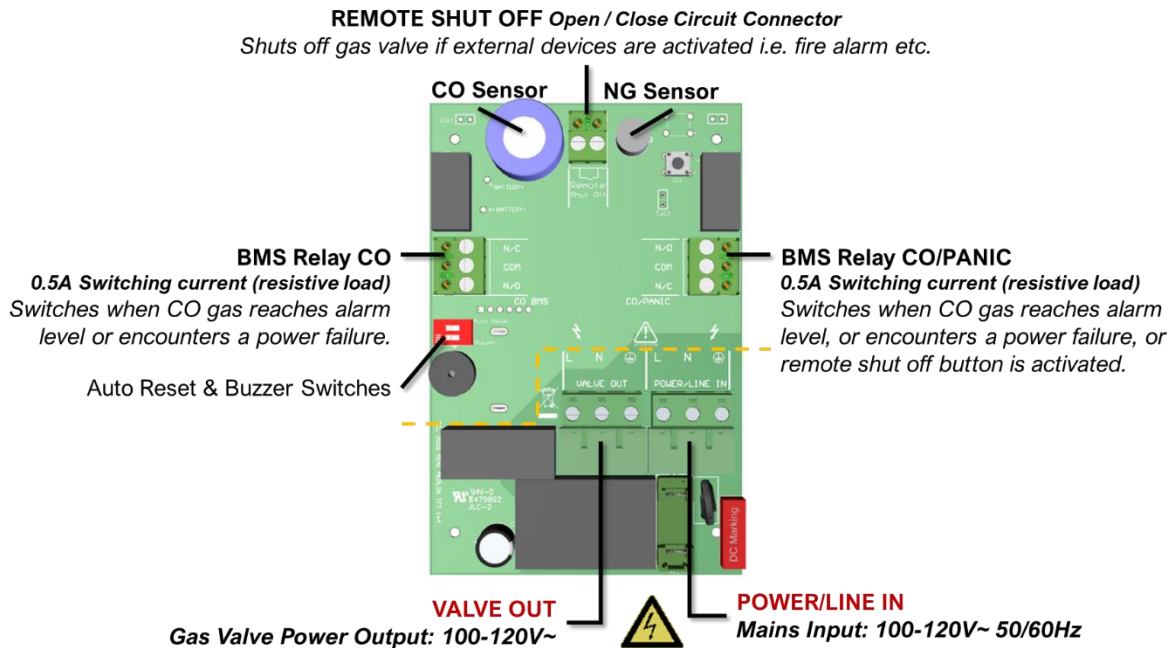

Wiring – Gas Solenoid Valve

- ⚠ **When the installation includes a standing pilot, ensure the internal auto reset dip switch is in the OFF position requiring a manual reset of the fuel supply!**

A gas solenoid valve should be powered using the terminals marked [VALVE OUT]. When the valve out terminal is wired to a normally closed (NC) gas solenoid valve, the device can be used to isolate the gas supply for multiple appliances. Use an external transformer (not supplied) to close a 24VAC gas solenoid valve that could supply gas to one or more appliances.

Gas Supply Controlled by 100-240VAC Solenoid Valve

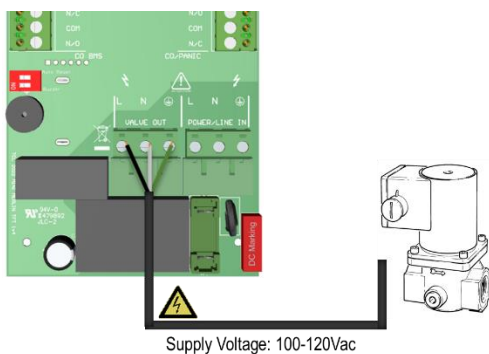

Gas Supply Controlled by 24VAC Solenoid Valve

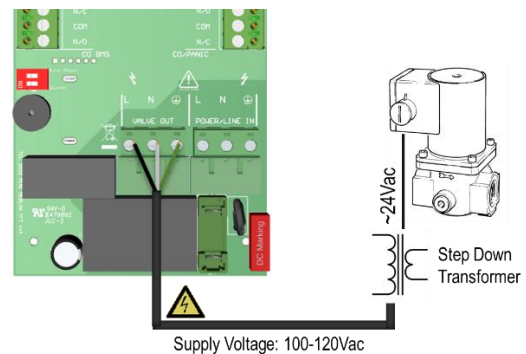

Wiring – Appliance Limit Circuits

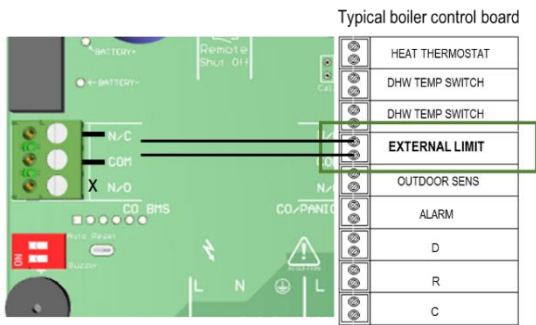

The device can be used to directly shut down a gas appliance when a fault condition is detected (gas leak) by wiring terminals of one BMS into the low voltage safety limit circuit of the appliance.

To connect both BMS to the safety limit circuit of an appliance - wire in series.

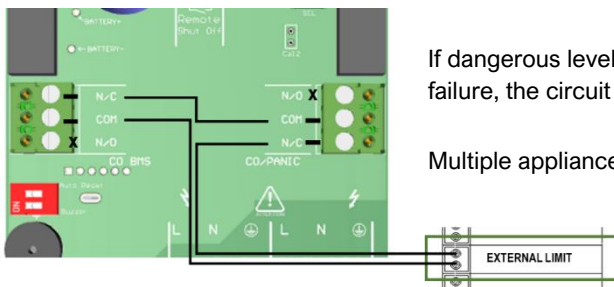

If dangerous levels of gas are detected or the mini merlin encounters a power failure, the circuit is opened, disabling the appliance.

Multiple appliance limit switches can be wired in series.

Wiring – Remote Shut Off

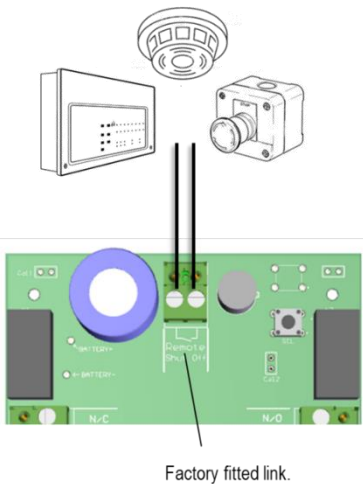

Your mini-merlin can be integrated with remote devices with an open /close circuit via the Remote Shut-Off volt free switch terminal.

This terminal has a factory fitted link installed. This terminal is normally closed and will alarm when energised open - isolating the gas supply.

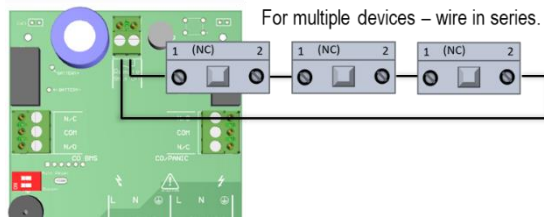

When using this input, only the mains utility output shall de-energize. If you are using the CO or NG relay to shut down a boilers external limit circuit, you will need to wire the input in series with the relay output.

Auto Reset & Buzzer Switches

	ON	OFF
Auto Reset	In the event of a power loss – the mini-merlin will restart automatically when power is restored.	In the event of a power loss – the mini-merlin will need to be reset manually when power is restored. This is the factory default condition.
Buzzer	The buzzer will sound every 15 seconds during pre-alarm and continuously at alarm level. This is the factory default condition.	The buzzer will not sound at any gas level.

Building Management System

This device can be integrated with a Building Management System (BMS), a home alarm system, or be used as part of a boiler low voltage safety limit to make or break a circuit on both gases separately, (valve open or valve closed) depending on the system.

These switches can be used for a variety of purposes including triggering alarm contacts, operating and external relay for multiple appliance shutdown and generating status signals for a BMS system.

Operation

Initial Power Up

- ⚠ When power is removed manually or due to an unpredicted power failure the CO and NG BMS circuit will change state switching off boilers/appliances via a limit switch if configured to do so!



When electrical power is supplied, press, and hold the touch sensor on the front cover for ~3 seconds. The detector enters a stabilisation phase for approximately one minute – during this period the device is not operational. If the detector has been configured to ‘Auto-Reset’ – your device will power up automatically when electrical power is supplied. To turn your device off, remove/isolate electrical power supply.

Digital Indications

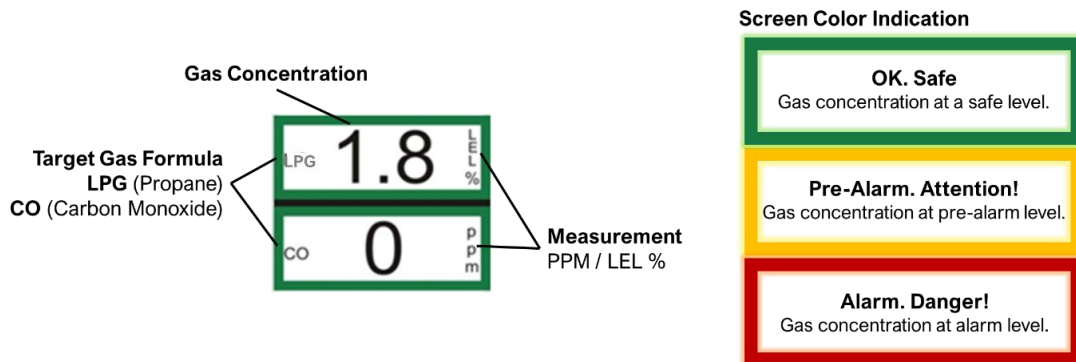

Alarm Set Points

- ⚠ When the detector reaches alarm levels the maximum concentration detected will be saved and the screen value will switch between the maximum (MAX) and the real time current value!
- ⚠ When the device has reached an alarm state, the concentration indicator will remain red even if gas levels are safe until the device is reset by pressing the touch sensor once!
- ⚠ An audible buzzer will sound if the internal buzzer switch is on!

Target Gas	Pre-Alarm	Buzzer	Alarm	Buzzer
Carbon Monoxide (CO)	▲ 20ppm	Beep every 15s	▲ 20ppm for two (2) hours ▲ 50ppm for one (1) hour ▲ 100ppm for ten (10) minutes ▲ 300ppm for one (1) minute	Continuous Sound
Propane (LPG)	▲ 8% LEL		▲ 10% LEL	

▲ Rising Alarm PPM (Parts Per Million) LEL% (Lower Explosive Limit)

Alarm Reset



To reset after an alarm - press the touch sensor once.

If the device enters an alarm state at any time, the gas level indicator will remain red to alert the user that a high/dangerous level of gas has been detected, until the device is reset.

Remote Shut Off Indication

A message will display if the device is integrated with remote shut off devices such as smoke or fire alarms etc. When activated, the device will isolate the gas supply if configured to do so. The mini merlin would need to be reset once any issues have been investigated and rectified.

Manual Circuit Simulation Test



The manual circuit test does not check the gas sensor itself!



Press and hold the touch sensor during normal operation.

This option gives the user the opportunity to test each relay/output in response to gas.

When the touch button is pressed and held during normal operation the mini merlin will simulate an open circuit to ensure all configured systems, outputs, alarms, indications, and other external devices operate as intended in response to gas.

End of Operational Life (EOL)



The EOL is approximate from the first five (5) hours of continuous power!



The EOL will depend on the type of gas your detector is targeting and may vary depending on its application and environmental conditions such as the frequency of exposure to the target gas, poisons, or inhibitors!

The typical life of a gas detector depends on its application and intended target gas, in addition the operational life can be prolonged if the system and equipment is installed and maintained in accordance the instructions stated within this manual.

At the end of its predicted operational life – the detector will display an ‘End of Life’ indication on screen. This message indicates that the detector has reached its expected operational lifecycle and no gas levels are displayed. You must contact your supplier immediately for replacement.

Maintenance

Cleaning

 **Concentrations of alcohol found in many products may damage, deteriorate, or affect the gas sensing elements such as wine; deodorants; stain removers and thinners. Other gases and substances to avoid are corrosives (i.e., chlorine & hydrogen chloride); alkali metals; basic or acidic compounds; silicones; tetraethyl lead; halogens and halogenated compounds!**

Keep your gas detector in good working order - follow these basic principles.

- Remove any dust/debris from the outer enclosure regularly using a slightly damp cloth.
- Never use detergents or solvents to clean your device.
- Never spray air fresheners, hair spray, paint or other aerosols near the device.
- Never paint the device. Paint will seal vents and interfere with the device.

Manual Circuit Simulation Test

 **The manual circuit test does not check the gas sensor itself!**



Press and hold the touch sensor during normal operation.

This option gives the user the opportunity to test each relay/output in response to gas.

When the touch button is pressed and held during normal operation the mini merlin will simulate an open circuit to ensure all configured systems, outputs, alarms, indications, and other external devices operate as intended in response to gas.

Bump Test (Gas Response Check)

What is a Bump Test?

Gas response checks are often referred to as a 'bump test'. Bump tests are important to make sure a device can detect a release of gas as early as possible. The aim of the bump test is to make sure a detector is working at its optimum by briefly exposing the unit to a known concentration of the target gas that usually exceeds the highest alarm point. If the detector goes into alarm and all signals/outputs activate, then the system is working safely.

If the system fails to operate as intended in an alarm state, the gas detector must not be used until a full inspection and service has been conducted. NFPA requires all gas detectors to be tested annually and that the test results be recorded on site and available to inspectors.

Why is it important?

A detector may visually appear in good working order, but its sensitivity and accuracy can be inhibited by external factors. Dust, humidity, temperature fluctuations, cleaning products, contaminants, exposure to its target gas or sensor drift (ageing) can cause a decline in sensitivity, accuracy, and eventual failure.

How often?











Regular bump tests are important to make sure the detector can detect a release of gas as early as possible and usually takes seconds (gas type dependant i.e., CO sensors will take over a minute) and is often completed alongside a scheduled fire alarm test, however the frequency should be determined following an appropriate risk assessment by the end user.

We recommend testing detectors every 12-18 months along with the regular fire test procedures and coincide with the annual service message prompted on the detection system after each year of service/operation.

What do I need?

Contact your S&S representative for details of suitable bump testing kits and gases. Kits usually consist of a certified gas cylinder or spray. We recommend only using S&S calibration gas kits to ensure correct flow rates meet S&S technical requirements. A bump testing gas is usually a concentration mix that exceeds the highest alarm set point.

Bump Test Procedure

-  **To increase reaction time, cover the escape vents at the sides of the device.**
-  **Always remove the regulator/valve if using a cylinder after use!**
-  **Always give at least five (5) minutes between testing the same unit or until gas has fully dispersed!**
-  **Always consider safety and use equipment in accordance with Safety Data Sheets!**
-  **Reference should always be given to any applicable national & local law and industry codes.**
-  **Generally, the gas concentration should be greater than the alarm threshold of the device.**
-  **Always remove the regulator/valve after use if using a cylinder!**
-  **All cylinders will re-seal upon removal of the regulator/valve!**
-  **Deviating from this test process is deemed improper and may affect the functional safety of your device!**
-  **Exposure to chemicals, smoke, or any other materials other than the gases intended to be monitored can seriously damage the gas sensing elements!**
-  **Always allow a minimum of 5 minutes before testing the same unit!**

1. Ensure you have the correct gas for the device type prior to application.
2. Offer up the applicator hose/cone or spray and apply to the small vents of the device located underneath.
3. Apply gas.
4. The device will enter alarm status after reaching alarm set point.
5. The device will activate all configured outputs/relays.

At this point...

6. Remove applicator hose/ cone or spray.
7. Reset by pressing the touch sensor.
8. Test complete.
9. Record your test details.

Page intentionally left blank

Page intentionally left blank

Specification

General							
Model:	Mini Merlin LPGCO						
Target Gases:	Propane/LPG & Carbon Monoxide						
Size: (H x W x D)	5.95 x 4.37 x 1.97" (151 x 111 x 50mm)						
Housing Material:	ABS PA765 (Flame Rating UL94 V-1)						
Mounting:	Safe Zone - Indoor use - Wall Mounted						
Weight:	12.24oz (0.347kg)						
User Interface							
Display:	1.8" TFT						
Screen Brightness:	Non-Adjustable						
Visual Indicators:	TFT visual. Green: Normal; Yellow: Pre-Alarm; Red: Alarm						
Audible Alarm:	>70dB @ 3.28ft (1m). Quiet conditions.						
Buttons:	Multi-Function – Initial Start / Reset / Circuit Test						
Language:	English						
Power Supply							
Power Consumption:	3W max						
AC Power:	100-240V~ 50/60Hz						
Internal Fuse:	Anti-Surge 3.15A 250Vac						
Equipment							
Overvoltage Category:	II						
Pollution Degree:	2						
Relays							
Volt Free BMS relay output:	0.5A switching current (resistive load)						
Environmental							
Ingress Protection:	Not Formally Evaluated						
Operating:	-10 ~ 50°C / 14 ~ 122°F 30 ~ 80% RH (non-condensing)						
Storage:	-25 ~ 50°C / -13~122°F up to 95% RH (non-condensing)						
Altitude Rating:	2000m						
Wiring							
Typical	Min. 18AWG / 75°C min / Tinned copper.						
Approvals							
Electrical Safety and Electromagnetic Compatibility	BS EN 61010-1:2010 A1:2019 UL61010-1/2012/R:2019-07. CAN CSA C22.2 No. 61010-1-12/A1:2018-11 EMC EN 61326-1:2013						
Sensor Specification							
Gas Sensor	Indicating Range	Steps	Response (t90)	Recovery (t10)	Alarm: 1 (Pre alarm warning)	Alarm: 2	*EOL (Years)
Electrochemical Sensors							
Carbon Monoxide (CO)	0-999ppm	1	<60s	<60s	▲ 20ppm	▲ 20ppm for two (2) hours ▲ 50ppm for one (1) hour ▲ 100ppm for ten (10) minutes ▲ 300ppm for one (1) minute	5
Semiconductor Sensors							
Propane (LPG)	0-20% LEL	0.1	<30s	<30s	▲ 8% LEL	▲ 10% LEL	10

▲ Rising Alarm ▼ Falling alarm *EOL – Expected Operational Life

Installation Details

Please pass this manual to the system owner / user.

Date of Installation:	
Installation Location:	
Organisation:	
Stamp/Signature of the installer:	

We recommend all S&S gas detection equipment be commissioned by competent/trained engineers to ensure correct installation and operation. The Merlin range of gas detectors are calibrated when manufactured, however, we strongly recommend the detectors response and alarm signals are tested and validated once installed. This will ensure the equipment performs as intended and is free from any unforeseen damage caused by transit/installation.

S&S Northern Limited

www.snsnorthern.com

S&S Northern Head Office

Tel: +44(0) 1257 470 983

Email: info@snsnorthern.com

Southeast Division

Tel: +44(0) 1702 291 725

Email: south@snsnorthern.com



S&S Northern is the owner of this document and reserves all rights of modification without prior notice.