



Merlin Gas Detector i-S

Refrigerant Gases

R No: Models: 134a / 407c / 410a / 417a / 32

Safe Area Safety Monitoring - General Gas Detection

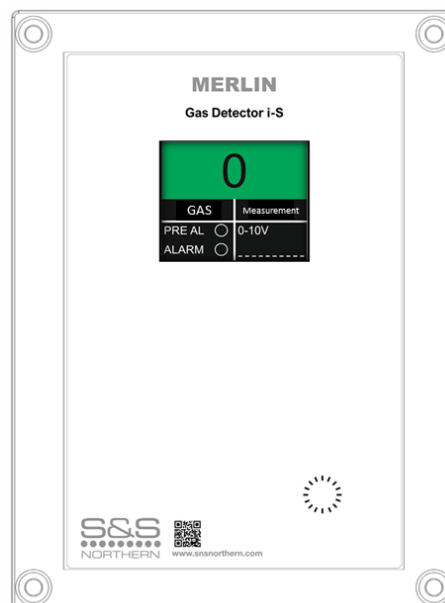

Installation, Operation & Maintenance

Please read this manual carefully and retain for future use.

For specific requirements that may deviate from the information in this guide – contact your supplier.

S&S Northern Limited

www.snsnorthern.com

Contents















Important Warning Statements	3
Installation	4
Typical Application & Location	4
Mounting & Cabling	5
Circuit Board Overview	6
Wiring: Power Input.....	6
Wiring: Alarm Relays.....	7
Alarm Relay Setting Switch – Latch On/Off.....	7
Wiring: 0-10V Analogue Output	7
Audible Buzzer Switch.....	7
Factory Set Condition.....	7
Operation	8
Initial Power Up.....	8
Latched Relay Alarm.....	8
Alarm Set Points.....	8
Maintenance	9
Cleaning	9
Manual Circuit Simulation Test	9
Bump Test (Gas Response Check)	9
Bump Test Procedure	10
End of Operational Life (EOL)	10
Specification	11

Important Warning Statements



Warning Symbol!

Where this symbol is used, consult the manual to understand the nature of any potential hazards and how to avoid them.

-  Please take the time to thoroughly read these instructions which should be retained for future reference.
-  Detectors are shipped pre-calibrated and configured.
-  The expected lifetime of a gas sensor is 10 years upon initial power up dependant on your target gas and environmental factors. The device will display a message to indicate this time and should immediately be replaced.
-  It is recommended that this device be commissioned upon installation and serviced annually by a competent person.
-  Do not apply lighter gas or other aerosols to the device – this will cause extreme damage to the sensors.
-  High concentrations of alcohol found in many products may damage, deteriorate, or affect the gas sensing elements.
-  This product is not designed to detect smoke, fire or other gases and should not be used as such.
-  This device provides early warning of the presence of gas, usually before a healthy adult would experience symptoms. This warning is possible provided your alarm is installed and maintained in accordance with this manual.
-  Never ignore your device when in alarm.
-  This device requires a continual supply of electrical power – it will not work without power.
-  This device should not be used to substitute proper installation, use and/or maintenance of fuel burning appliances including appropriate ventilation and exhaust systems.
-  Multiple detectors may be required to adequately protect property and persons.
-  This device does not prevent dangerous gasses from occurring or accumulating.
-  The device is not intended for use in potentially explosive atmospheres.
-  Seek fresh air supply and contact your local gas emergency service should you suspect a gas leak.
-  This unit may not fully safeguard individuals with specific medical conditions. If in doubt, consult a doctor/physician.
-  Your product should reach you in perfect condition, if you suspect it is damaged, contact your supplier.
-  The sensor should avoid exposure to silicon adhesive, hair spray, silicon rubber, putty or other places where volatile silicon compounds exist. If silicon compound vapor is adsorbed on the surface of the sensor, the sensitive material of the sensor will be wrapped by the silicon dioxide formed by the decomposition of the silicon compound, which inhibits the sensitivity of the sensor and cannot be recovered.
-  Exposure of the sensor to high concentrations of corrosive gases (such as H₂S, SO₂, Cl₂, HCl, etc.) will not only cause the key materials inside the sensor to be corroded or destroyed, but also cause irreversible deterioration of the performance of sensitive materials.
-  When the sensor is polluted by alkali metal, especially saltwater spray, it will cause performance deterioration.
-  Splashing or immersing in water will cause the sensor's sensitivity to decrease.
-  Water freezing on the surface of the sensor's sensitive material will cause the sensitive layer to break and lose its sensitivity.
-  Under indoor use conditions, slight condensation will have a slight impact on the performance of the sensor. However, if water condenses on the surface of the sensitive layer and keeps it for a period, the sensor characteristics will decrease.

Information on waste disposal for consumers of electrical & electronic equipment.

When this product has reached the end of its life it must be treated as Waste Electrical & Electronics Equipment (WEEE). Any WEEE marked products must not be mixed with general household waste, but kept separate for the treatment, recovery and recycling of the materials used. Please contact your supplier or local authority for details of recycling schemes in your area.



At the end of their working life, electrochemical sensors should be disposed of in an environmentally safe manner. Alternatively, they can be securely packaged and returned to S&S clearly marked for disposal. Electrochemical sensors should not be incinerated as this may cause the cell to emit toxic fumes.

Installation

Typical Application & Location

- ⚠ **Installation must be carried out by a licenced, insured contractor!**
- ⚠ **Ensure that detectors are not exposed to liquid or dust contamination!**
- ⚠ **Detectors and cables must be protected against mechanical damage!**
- ⚠ **Avoid conditions of any other environmental factors outside of the specification that could potentially impede the accuracy and operation of the detector such as condensation; vibration; temperature, pressure, the presence of other gases, electromagnetic interference, and draft zones!**
- ⚠ **The target gas will only be identified when contact is made with the sensing element itself!**

Gas detectors should be installed in areas at risk of gas leaks e.g., near boilers, valves, or meters, located in positions determined by those who have knowledge of gas dispersion, the process plant system and equipment involved, and in consultation with both safety and electrical engineering personnel.

Take in to account the design of the air flow patterns within the area. Detectors should be installed in the correct orientation, as recommended, and ease of access should be accounted for to allow for any bump tests and other forms of maintenance throughout its operating life.

There are no official figures of the area coverage of a gas detector; however, 50m² per detector is a reasonable general guide therefore multiple detectors may be required to adequately protect property and persons. There are no specific standards governing gas detector location (unlike fire detection systems); there are, however, general guidance documents. The most relevant being *IEC 60079-29-2: Explosive Atmospheres – Part 29: Gas detectors – Selection, installation, use and maintenance of detectors for flammable gases and oxygen*. Much of what it covers is also relevant to toxic gas detection.

Recommended heights may vary based on air flow and temperature conditions in addition to the proposed application and location. Locations for detectors will vary based on the intended application and target gas, they should be located near identified sources of a potential gas leaks/pockets where gas could quickly accumulate and areas of identified consequential risk to detect gas. The composition of the target gas and its density relative to air are used as the basis for the recommended height of sensors. Generally, the installation height of a sensor for a heavy gas (e.g., propane) would be close to the lowest point in the area, and for a light gas (such as methane) would be close to the highest point in the area. These typical positions may vary based on air flow and temperature conditions in addition to the proposed application and location – this is particularly apparent with oxygen depletion sensors, and the target gas that they are used for.

Typical Position

Low Level - 300mm (1ft) from lowest point

If you are installing and monitoring oxygen depletion monitors – consider the density of gas for its application and position the detector accordingly i.e., ground level for high-density gases.

Detectors should be mounted where a potential hazard of gas is most likely to be present. The following points should be noted also when locating gas sensors. When locating detectors consider

- The possible damage caused by natural events e.g., rain or flooding.
- Ease of access to the gas detector for functional testing and servicing.
- How gas may behave due to natural or forced air currents.

Mounting & Cabling

- ⚠ If mounting direct to wall - ensure the wall surface is flat to prevent base distortion!
- ⚠ Ensure the rear base is installed in the correct orientation as shown!
- ⚠ Where cable glands/conduits are used for wire entry, use 20mm (3/4 inch) max separated by at least 20mm!
- ⚠ Any parts that form part of the connections/installation must have a minimum fire-retardant rating of UL94v-2!
- ⚠ Fill any holes drilled to maintain integrity of the equipment!
- ⚠ Damage to PCBs when creating cable entry points or attempting to remove the circuit board may void any warranty!
- ⚠ The monitor is designed for either surface mounting or mounted on a one or two gang electrical box.
- ⚠ Restrain the hazardous live wiring from accidental loosening to prevent wires from moving after installation and touching parts of opposite polarity or at low voltages!
- ⚠ Isolate the equipment from all hazardous live power sources before opening the cover!

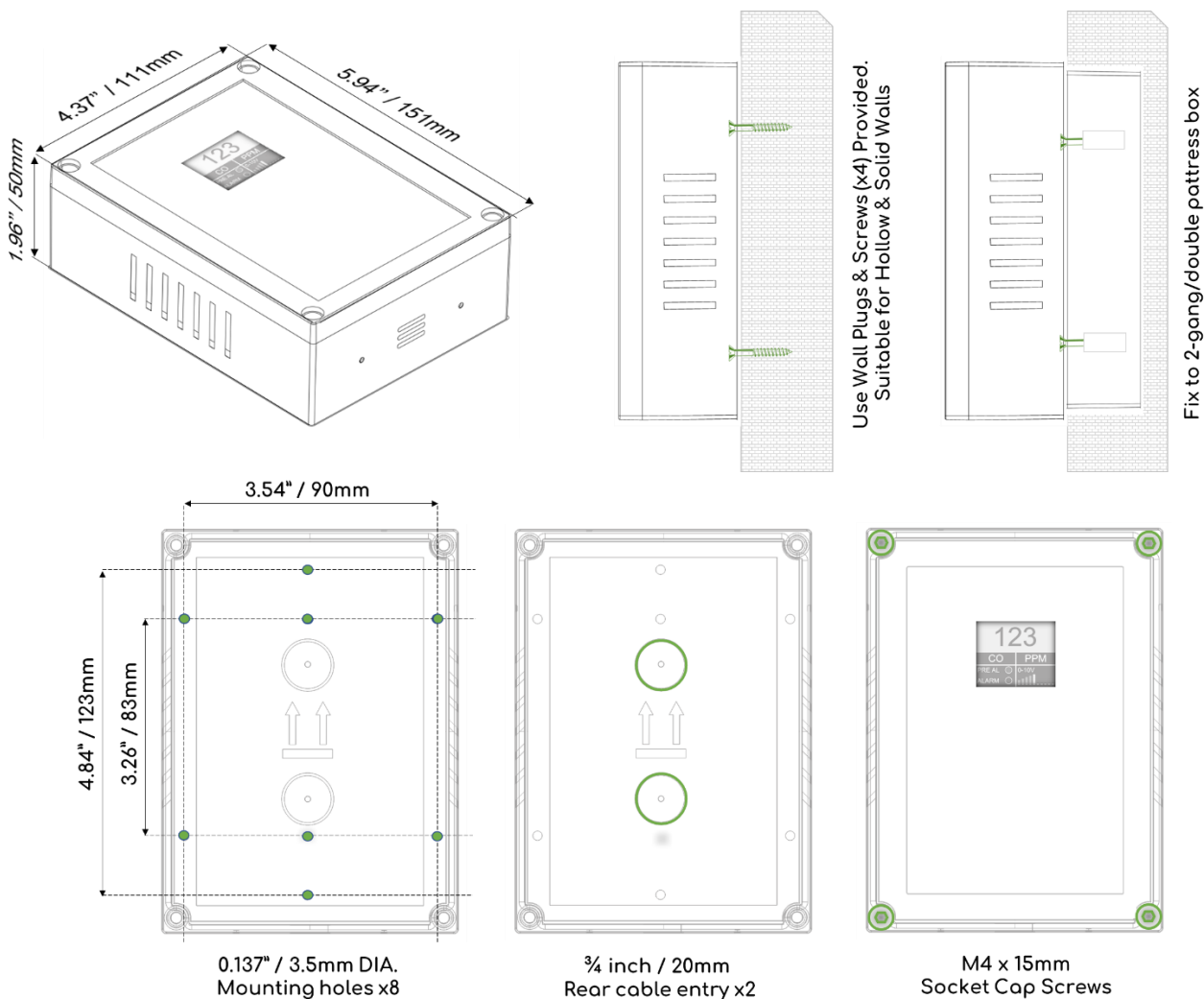

1. Carefully remove the front cover from the unit by using an M3 socket wrench.
2. Using the rear base - mark mounting holes to the wall or align with a vertical 2-gang/pattress box.
3. Fixing straight to wall – drill 0.2" (5mm) hole, insert plugs and use the four screws (No.4 Pozi) provided.
4. There are pre-fractured areas for cable entry on the rear of the base and pilot holes positioned on the top and bottom of the enclosure suitable for entry points up to 3/4" (20mm). Drill out as necessary ensuring all swarf is removed from the box and holes have smooth edges.
5. After executing the mounting/connections – secure the front cover with all M4 bolts and insert security caps provided.

Circuit Board Overview

- ⚠ **Damage to PCBs when creating cable entry points may void any warranty!**
- ⚠ **Any damage attempting to remove the circuit board may void any warranty!**
- ⚠ **A disconnecter is required and accessible for the 24V supply and an adequate overcurrent device is fitted!**

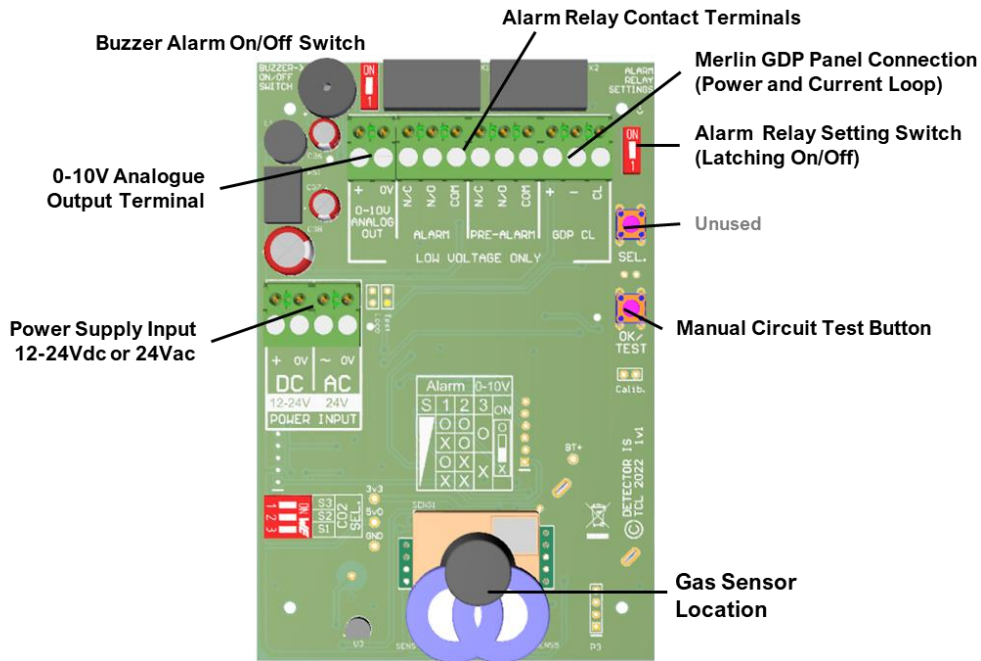

Wiring: Power Input

Standalone Power

Power can be provided either 24Vac or 12-24vdc. Terminals are pluggable type to ease connections.

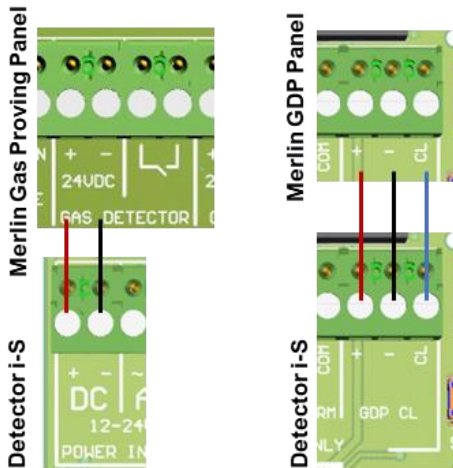
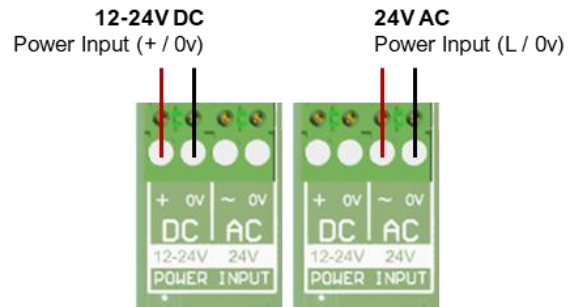

Merlin GDP Controller

Power is supplied via the GDP terminal [+ / -]. Use the [C/L] terminal as an alarm relay. Wire in parallel for multiple detectors.

Merlin Gas Proving Controller

Power is supplied via the 24VDC terminal [+ / -]. Use the open/close terminal as an alarm relay to detectors.

Wiring: Alarm Relays

These are volt free connections to a BMS (building management systems) or Merlin panel to send an alarm signal upon pre/alarm levels of gas. Max 1A load @ 12/24Vdc or ac.

If you are connecting detector(s) via a GDP panel you will need to use the [C/L] terminal as an alarm relay. A relay will change state when in alarm or pre-alarm when gas is detected and if wired/configured to do so. These terminals can be used in conjunction with other external relays that affect other devices and controls such as purge fans and audible alarms etc.

Alarm Relay Setting Switch – Latch On/Off

 **The switch is left on as a factory set condition!**



This switch is used to latch/unlatch an alarm relay.

When turned on the Detector relay will latch permanently on (until reset) in the event of the detector detecting gas and entering an alarm state. The detector will indicate a red dot on the screen when the alarm relay has latched. The audible alarm alerts the user that the detector entered an alarm state.

To reset the detector, press and hold the touch button for ~3 seconds.

Wiring: 0-10V Analogue Output

This connection is used to regulate external fan speed controllers (supplied separately).

Connect direct to fan speed controllers or via your Merlin panel [0-10V] terminal if available.

0-10V output is driven by the status of gas concentrations detected.

0-10V Output	5V	10V
R gas level (ppm)	>500	>1000

Audible Buzzer Switch

There is a switch on the detector board identified as [Buzzer On/Off].

The detector can be configured to have an audible alarm or not when gas levels reach the alarm set points. The alarm will continuously sound – there are no provisions to silence the alarm, gas levels must drop to a safe value for the alarm to stop.

Factory Set Condition

 **Detectors are shipped pre-calibrated and configured.**

Buzzer On/Off Switch	On
Alarm Relay Setting Switch	On

Operation

Initial Power Up

On connecting power, the detector enters a warmup phase for approximately 60 seconds – during this period, your device not yet ready for operation.

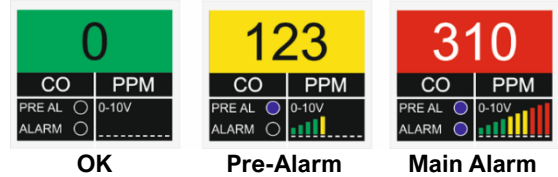
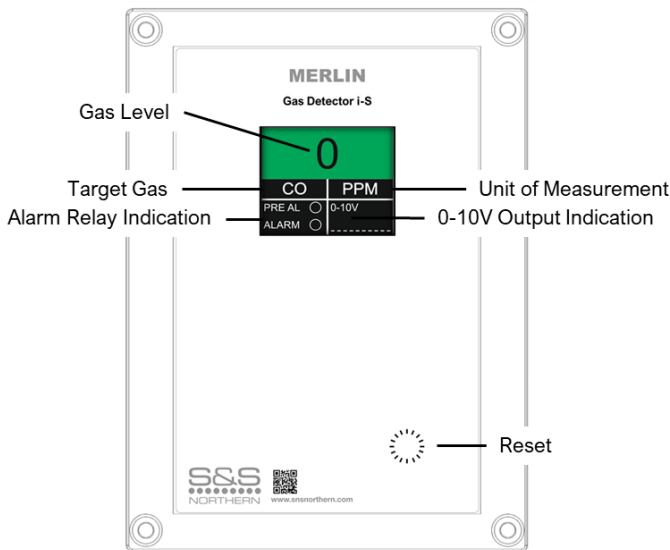

Latched Relay Alarm

The detector will indicate a red dot on the screen when the alarm relay has latched.



The audible alarm will alert the user that the detector has entered a main alarm state. To reset the detector, press and hold the touch sensor for ~3s.

Alarm Set Points

⚠ An audible buzzer will sound if the buzzer switch on the circuit board is on!

LOW Pre-Alarm	Buzzer	HIGH Main Alarm	Buzzer
▲ 500ppm ▼ 800ppm	None	▲ 1000ppm	Continuous sound

▲ Rising alarm ▼ Falling alarm (PPM) Parts Per Million

Maintenance



Cleaning

-  **Concentrations of alcohol found in many products may damage, deteriorate or affect the gas sensing elements such as; wine; deodorants; stain removers and thinners. Other gases and substances to avoid are corrosives (i.e., chlorine & hydrogen chloride); alkali metals; basic or acidic compounds; silicones; tetraethyl lead; halogens and halogenated compounds!**

Keep your gas detector in good working order - follow these basic principles.

- Remove any dust/debris from the outer enclosure regularly using a slightly damp cloth.
- Never use detergents or solvents to clean your device.
- Never spray air fresheners, hair spray, paint or other aerosols near the device.
- Never paint the device. Paint will seal vents and interfere with the device.

Manual Circuit Simulation Test

-  **Access to the interior of the detector, when carrying out any work, must be conducted by a competent person!**
-  **This circuit test does not check the gas-sensing element itself!**

When the test button on the circuit board is pressed and held for ~3seconds the detector will simulate an open circuit to ensure configured systems, outputs, alarms, indications, and other external devices operate as intended in response to gas. The test sequence will automatically terminate after a short period of time and return to normal operation.

Bump Test (Gas Response Check)

What is a Bump Test?

Gas response checks are often referred to as a 'bump test'. Bump tests are important to make sure a device can detect a release of gas as early as possible. The aim of the bump test is to make sure a detector is working at its optimum by briefly exposing the unit to a known concentration of the target gas that usually exceeds the highest alarm point. If the detector goes into alarm and all signals/outputs activate, then the system is working safely.

If the system fails to operate as intended in an alarm state, the gas detector must not be used until a full inspection and service has been conducted.

Why is it important?

A detector may visually appear in good working order, but its sensitivity and accuracy can be inhibited by external factors. Dust, humidity, temperature fluctuations, cleaning products, contaminants, exposure to its target gas or sensor drift (ageing) can cause a decline in sensitivity, accuracy, and eventual failure.

How often?

Regular bump tests are important to make sure the detector can detect a release of gas as early as possible and usually takes seconds (gas type dependant i.e., CO sensors will take over a minute) and is often completed alongside a scheduled fire alarm test, however the frequency should be determined following an appropriate risk assessment by the end user. We recommend testing detectors every 12-18 months along with the regular fire test procedures and coincide with the annual service message prompted on the detection system after each year of service/operation.

What do I need?

Contact your S&S representative for details of suitable bump testing kits and gases. Kits usually consist of a certified gas cylinder or spray. We recommend only using S&S calibration gas kits to ensure correct flow rates meet S&S technical requirements. A bump testing gas is usually a concentration mix that exceeds the highest alarm set point.

Bump Test Procedure

- ⚠ To increase reaction time, cover the escape vents at the sides of the device.
- ⚠ Always remove the regulator/valve if using a cylinder after use!
- ⚠ Always give at least five (5) minutes between testing the same unit or until gas has fully dispersed!
- ⚠ Always consider safety and use equipment in accordance with Safety Data Sheets!
- ⚠ Reference should always be given to any applicable national & local law and industry codes.
- ⚠ Generally, the gas concentration should be greater than the alarm threshold of the device.
- ⚠ Always remove the regulator/valve after use if using a cylinder!
- ⚠ All cylinders will re-seal upon removal of the regulator/valve!
- ⚠ Deviating from this test process is deemed improper and may affect the functional safety of your device!
- ⚠ Exposure to chemicals, smoke, or any other materials other than the gases intended to be monitored can seriously damage the gas sensing elements!
- ⚠ Always allow a minimum of 5 minutes before testing the same unit!

1. Ensure you have the correct gas for the device type prior to application.
2. Offer up the applicator hose/cone or spray to the small vents of the device located underneath.
3. Apply gas.
4. The device will enter alarm status after reaching alarm set point.
5. The device will activate all configured outputs/relays.
6. Reset by pressing and holding the touch sensor for ~3s.
7. Test complete.
8. Record your test details.

End of Operational Life (EOL)

- ⚠ The EOL is approximate from the first five (5) hours of continuous power!
- ⚠ The EOL will depend on the type of gas your detector is targeting and may vary depending on its application and environmental conditions such as the frequency of exposure to the target gas, poisons, or inhibitors!



The typical life of a gas detector depends on its application and intended target gas, in addition the operational life can be prolonged if the system and equipment is installed and maintained in accordance the instructions stated within this manual.

At the end of its predicted operational life – the detector will display an ‘End of Life’ screen. This message indicates that the detector has reached its expected operational lifecycle and no gas levels are displayed. You must contact your supplier immediately for replacement.

Specification

General							
Model:	Detector i-S						
Target Gas(es):	R No: 134a / 407c / 410a / 417a / 32						
Size: (H x W x D)	5.95 x 4.37 x 1.97" (151 x 111 x 50mm)						
Housing Material:	ABS PA765. Flame Retardant UL 94V-1						
Mounting:	Safe Zone - Indoor use - Wall Mounted						
Weight:	212g						
User Interface							
Display:	1.8" TFT						
Screen Brightness:	Non-Adjustable						
Visual Indicators:	Gas Level (Green: Normal; Yellow: Pre-Alarm; Red: Alarm) 0-10V Output: Relay Output						
Audible Alarm:	>65dB @ 3.28ft (1m). Quiet conditions.						
Language:	English						
Power Supply							
Rated Power:	1.8W Max						
Rated Voltage:	12-24Vdc or 24Vac						
Relays							
Volt Free relay outputs:	1A switching current (resistive load) @ 24V AC/DC						
Environmental							
Ingress Protection (IP):	Not Formally Evaluated						
Operating:	-10 ~ 50°C / 20 ~ 90% RH (non-condensing)						
Storage:	0 ~ 50°C / 30 - 80% RH (no condensation)						
Altitude Rating:	2000m						
Wiring							
Typical	Min. 2.5mm ² / 75°C min / Tinned copper.						
Approvals							
Electrical Safety & EMC	CE / UKCA IEC 61010-1:2010 +A1:2019. & BS EN 50270 / FCC CFR 47 Parts 15, 107 & 109						
Sensor Specification							
Gas Sensor	Measuring Range	Steps	Response (t ₉₀)	Recovery (t ₁₀)	Pre-Alarm:	Alarm:	*EOL (Years)
Semi-Conductor							
	100-5000ppm	1	<60s	<60s	▲ 500ppm ▼ 800ppm	▲ 1000ppm	10

▲ Rising Alarm ▼ Falling alarm / *EOL – Expected Operational Life / PPM Parts Per Million

Installation Details

Please pass this manual to the system owner / user.

Date of Installation:	
Installation Location:	
Organisation:	
Stamp/Signature of the installer:	

We recommend all Merlin gas detection equipment be commissioned by competent/trained engineers to ensure correct installation and operation. The Merlin range of gas detectors are calibrated when manufactured, however, we strongly recommend the detectors response and alarm signals are tested and validated once installed. This will ensure the equipment performs as intended and is free from any unforeseen damage caused by transit/installation.

Manufacturer's Warranty

Warranty coverage: The manufacturer warrants to the original consumer purchaser, that this product will be free of defects in material and workmanship for a period of three (3) years from date of purchase.

The manufacturer's liability hereunder is limited to replacement of the product with repaired product at the discretion of the manufacturer. This warranty is void if the product has been damaged by accident, unreasonable use, neglect, tampering or other causes not arising from defects in material or workmanship. This warranty extends to the original consumer purchaser of the product only.

Warranty disclaimers: Any implied warranties arising out of this sale, including but not limited to the implied warranties of description, merchantability and intended operational purpose, are limited in duration to the above warranty period. In no event shall the manufacturer be liable for loss of use of this product or for any indirect, special, incidental, or consequential damages, or costs, or expenses incurred by the consumer or any other user of this product, whether due to a breach of contract, negligence, strict liability in tort or otherwise. The manufacturer shall have no liability for any personal injury, property damage or any special, incidental, contingent or consequential damage of any kind resulting from gas leakage, fire, or explosion. This warranty does not affect your statutory rights.

Warranty Performance: During the above warranty period, your product will be replaced with a comparable product if the defective product is returned together with proof of purchase date. The replacement product will be in warranty for the remainder of the original warranty period or for six months – whichever is the greatest.

Every effort is made to ensure the accuracy of this document; however, S&S Northern can assume no responsibility for any errors or omissions in this document or their consequences. S&S Northern would greatly appreciate being informed of any errors or omissions that may be found in the content of this document. For information not covered in this document, or if there is a requirement to send comments/corrections, please contact S&S Northern using the contact details given below.

S&S Northern Limited

www.snsnorthern.com

S&S Northern Head Office

Tel: +44(0) 1257 470 983

Email: info@snsnorthern.com

Southeast Division

Tel: +44(0) 1702 291 725

Email: south@snsnorthern.com



S&S Northern is the owner of this document and reserves all rights of modification without prior notice.