



MINI MERLIN CH4CO

Dual Gas Detector

Methane & Carbon Monoxide



Installation & Operation Manual

Please read this manual carefully and retain for future use.

Your new Mini Merlin is a dual gas sensor carefully designed and tested to monitor levels of Methane (CH₄) and Carbon Monoxide (CO) in the air. If there is a dangerous build-up of gas or unsafe levels of carbon monoxide at the sensor, this device can shut off the gas supply via a gas safety valve and/or a gas fired appliance.

This device has additional features for resetting systems, as well as audible and visual alarms - It can also be integrated with a Building Management System (BMS).

Table of contents

CARBON MONOXIDE GAS	3
General Information	3
METHANE GAS	4
General Information	4
INSTALLATION	5
Planning.....	5
Typical Location and Positioning.....	5
Fixing	6
Board Overview	7
Building Management System Integration.....	7
Wiring the Device	8
Audible Alarm Switch	9
Auto Reset Switch.....	9
Factory Set Condition.....	9
Trouble Shooting	9
Specification	10
OPERATION	11
First Power Up	11
Gas Level Display	11
Audible Alarm Characteristics	11
Touch Button	12
Remote Shut Off	12
End of Life Indicator	12
Maintenance	12
IMPORTANT WARNING STATEMENTS	13
Manufacturer's Warranty.....	13

CARBON MONOXIDE GAS

General Information

Carbon monoxide (CO) is a poisonous, colourless, odourless, and tasteless gas. Although it has no detectable odour, CO is often mixed with other gases that do have an odour. So, you can inhale carbon monoxide right along with gases that you can smell and not be aware that CO is present.

SYMPTOMS OF CARBON MONOXIDE GAS POISONING

The following symptoms are related to CO poisoning and should be discussed with ALL members of the household, facility or person/s frequenting monitored areas.

Mild Exposure:

Slight headache, nausea, vomiting, fatigue, flu-like symptoms.

Medium Exposure:

Severe headache, drowsiness, confusion, increased heart rate.

Extreme Exposure:

Unconsciousness, convulsions, cardio-respiratory failure, death.

If you experience even mild symptoms of CO exposure – consult a doctor/ physician immediately.

CARBON MONOXIDE GAS LEVELS – PARTS PER MILLION

This device is equipped with a digital display that shows levels of CO (displayed in PPM: parts per million).

Dangerous levels:

Generally above 100ppm. This should be treated as an urgent situation.

Medium levels:

Generally between 50ppm to 100ppm. This should be cause for concern and should not be ignored or dismissed.

Low levels:

Maximum acceptable indoor level of CO is <9ppm.

Anything above this level may cause possible health effects with long-term exposure.

See the specification table (5) for how your device monitors CO.

POSSIBLE SOURCES OF CARBON MONOXIDE GAS

Inside your home or facility, gas appliances used for heating, water heating and cooking are the most likely sources of CO. Vehicles running in attached garages can also produce dangerous levels of CO.

CO can be produced when burning any fossil fuel, such as gasoline, propane, natural gas, oil and wood. It can be produced in any fuel burning appliance that is malfunctioning, improperly installed or insufficiently ventilated.

- Automobiles, gas stoves, water heaters, portable fuel burning heaters, fireplaces.
- Blocked chimneys or flues, corroded or disconnected vent pipes.
- Vehicles and other combustion engines running in open or confined spaces.
- Burning charcoal or fuel in grills in an enclosed area or near the home.

For more information, please visit our website or contact us.

METHANE GAS

General Information

Methane gas comes from the earth and it comes from our bodies. Methane is non-toxic and it can be harnessed as an energy source. However, methane is highly explosive and it can cause death by asphyxiation. It is important to understand how to deal with the hazards associated with methane.

Although methane on its own isn't poisonous, it has the potential to become poisonous when mixed with other substances. That potential exists when natural gas (CH₄), which is 97% methane, is burned in houses, offices and businesses. The burning of natural gas without proper ventilation can produce carbon monoxide, a deadly gas that is difficult to detect.

SYMPTOMS OF METHANE GAS EXPOSURE

Methane gas is relatively non-toxic and associated with being a simple asphyxiator displacing oxygen in the lungs. However Methane is extremely combustible.

Exposure to high levels of Methane can cause:

- Suffocation
- Loss of consciousness
- Headache and dizziness
- Nausea and vomiting
- Weakness
- Loss of co-ordination
- Increased breathing rate

METHANE GAS LEVELS - %

The LEL (Lower Explosive Limit) of methane is considered to be 5% BV (by volume of air). So we call 5% BV (by volume) the same as 100% of the LEL (Lower Explosion Limit).

Your device is equipped with a digital display that shows the level of natural gas in the area referred to as LEL% (a percentage of the LEL) and will alarm based on the following principle of gas detection.

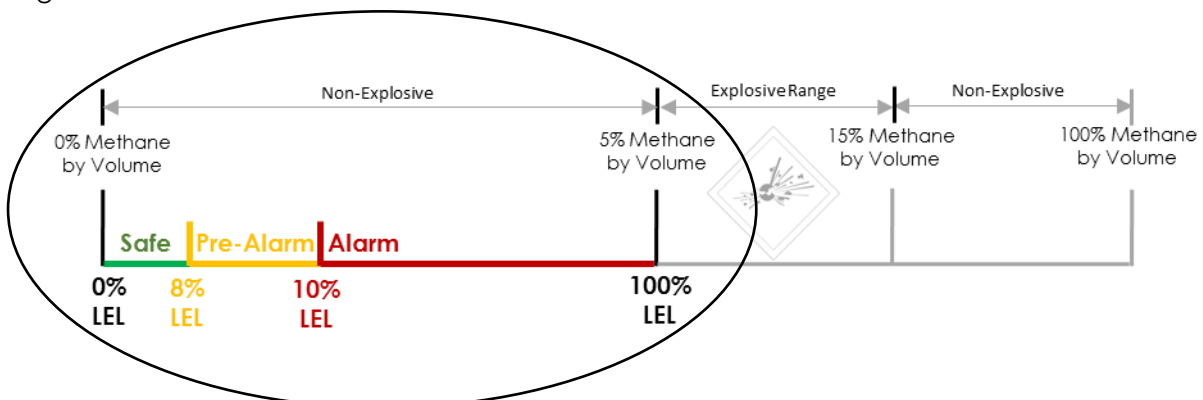

In simplified terms, a level of 8% LEL or less on your device is generally considered safe and acceptable.

For more information, please visit our website or contact us.

INSTALLATION

Planning

Our monitors should be installed in areas at risk of gas leaks e.g. over boilers, valves or meters.

Take in to account the design of the air flow patterns within the zone area.

Detectors should be installed in the correct orientation, as recommended by the manufacturer, and ease of access should be accounted for to allow for any bump tests, recalibration and other forms of maintenance.

Areas to avoid

Avoid conditions of any other environmental factors that could potentially impede the accuracy and operation of the detector such as; condensation; vibration; temperature, pressure, the presence of other gases, electromagnetic interference and draft zones.

Area of coverage

Consider the coverage required and function of the area. Emphasis should be placed on airflow patterns and correct placement, not perceived detecting ranges. The target gas will only be identified when contact is made with the sensing element itself.



Multiple detectors may be required to adequately protect property and persons.

Typical Location and Positioning

Locations for detectors will vary based on the intended application, they should be located near identified sources of a potential gas leaks/ pockets where hazardous gas could quickly accumulate and areas of identified consequential risk.

Recommended heights may vary based on air flow and temperature conditions in addition to the proposed application and location.

The device should be mounted near the boiler or gas fired appliance/s such as domestic & commercial boiler rooms and basements.

When choosing your location, make sure you are able to hear the alarm from all areas.

- DO place the device at eye level to optimise monitoring of the digital display.
- DO place out of reach of children.
- AVOID installation within 6 feet (2 metres) of heating or cooking appliances.
- AVOID Installation near any ventilation openings, i.e. vents, chimneys, windows etc.
- AVOID installation near ceiling fans, windows or areas exposed to direct weather.

Fixing

Unpack all the parts!

This device is designed for surface mounting using 2 mounting screws (not supplied) and **MUST** be installed by a licensed insured contractor.

Mark the location of the two holes needed on the wall using the back plate as a template. Placing at eye level allows for optimum monitoring of the digital display screen, or as guide, 5 feet (1.5 meters) from ground level.

Back Plate

Removing the back plate gives access to the circuit board.

There are also two 'knock outs' for electrical wiring access & a divider to separate low and high voltage connections.

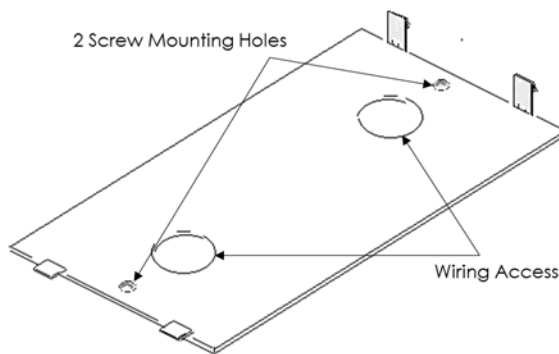

Do not remove the Circuit Board!

This will void any warranty.

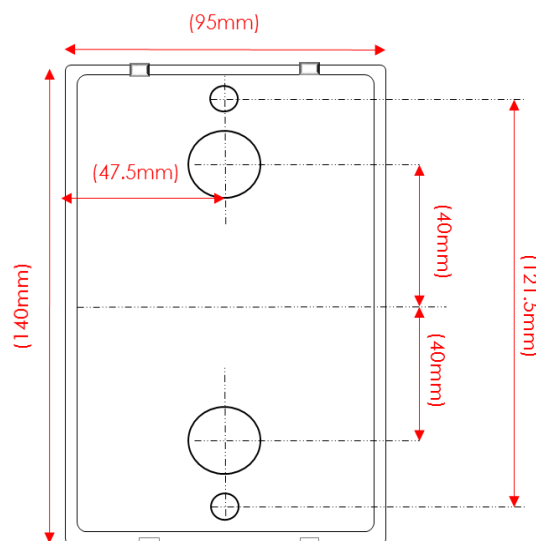

Board Overview

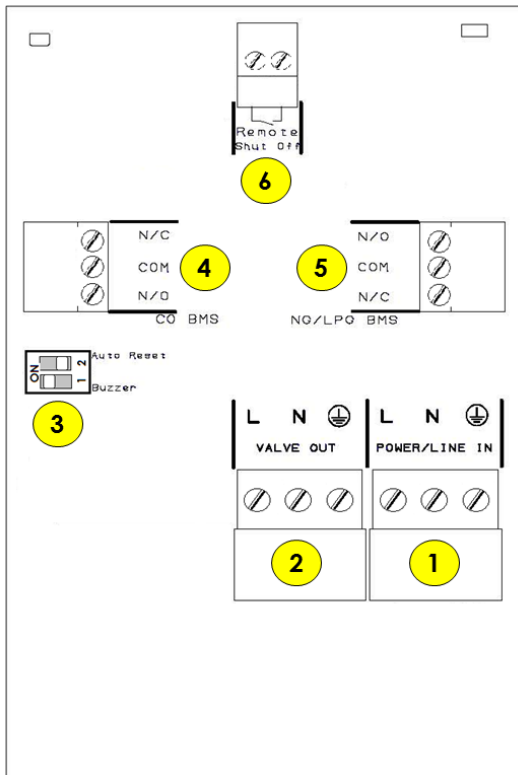

1. POWER/LINE IN

Mains power input. 110-240v AC

2. VALVE OUT

Gas valve power output. 110-240v AC

3. AUTO RESET & BUZZER SWITCH

4. CO BMS

Relay will switch when CO gas reaches the alarm level.

5. NG/ LPG BMS

Relay will switch when CH4 gas reaches the alarm level.

6. REMOTE SHUT OFF

Closed out as a factory setting and during normal operation, this input shuts off the gas valve relay in the event of external detectors being triggered.

Do not attempt to remove the Circuit Board! This will void any warranty.

Auto Reset and Buzzer Switch options

	Auto Reset	Buzzer
OFF	When the power is restored after a power loss, the unit must be restarted manually	The audible alarm will not sound at any level but the digital display gas level indicators will remain active.
ON	This will instruct the unit to restart automatically when power is restored.	The alarm will sound every 15 seconds during pre-alarm gas levels and continuously when gas levels are high.

Building Management System Integration

This device can be integrated with a Building Management System (BMS), a home alarm system, or be used as part of a boiler low voltage safety limit to make or break a circuit on both gases separately, (valve open or valve closed) depending on the system.

These switches can be used for a variety of purposes including triggering alarm contacts, operating and external relay for multiple appliance shut-down and generating status signals for a BMS system.

Wiring the Device

Gas Supply Controlled by 100-240VAC Solenoid Valve

A 110-240VAC gas solenoid valve should be powered using the terminals marked [VALVE OUT].

When the GAS VALVE terminal is wired to a normally closed (NC) gas solenoid valve, the device can be used to isolate gas supply for multiple appliances.

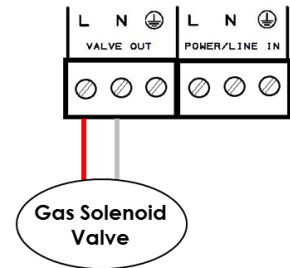

If you use a gas solenoid valve, please note that standing pilots will need to be re-lit.

⚠ CAUTION: We do not recommend installing a gas solenoid valve with standing pilots.

Appliance Limit Circuit

The device can be used to directly shut down a gas appliance when a fault condition is detected (gas leak), by wiring the normally closed (NC) and common (COM) terminals of the low volt BMS switches into the low voltage safety limit circuit of the appliance.

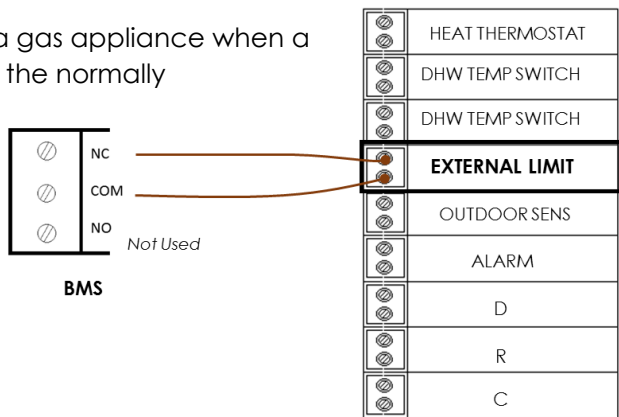

If gas is detected, the limit circuit is opened, disabling the appliance.

To connect both **CO** and **NG** to the safety limit circuit of an appliance - wire in series as per the following diagram.

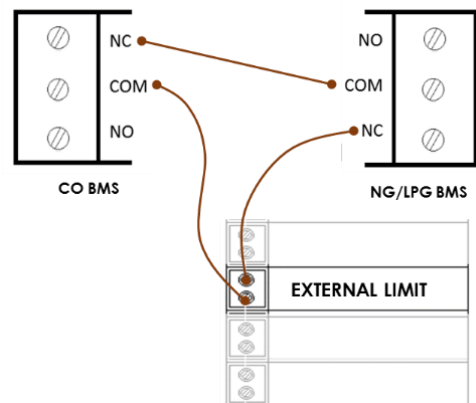

Remote Shut Off

Your device has a facility for remote devices to be connected. The [Remote Shut Off] terminal is NC (Normally Closed) and will alarm when energised Open.

Remote devices cut off the gas supply when activated.

To reset the device after a remote shut off has been activated – press the Touch Button.

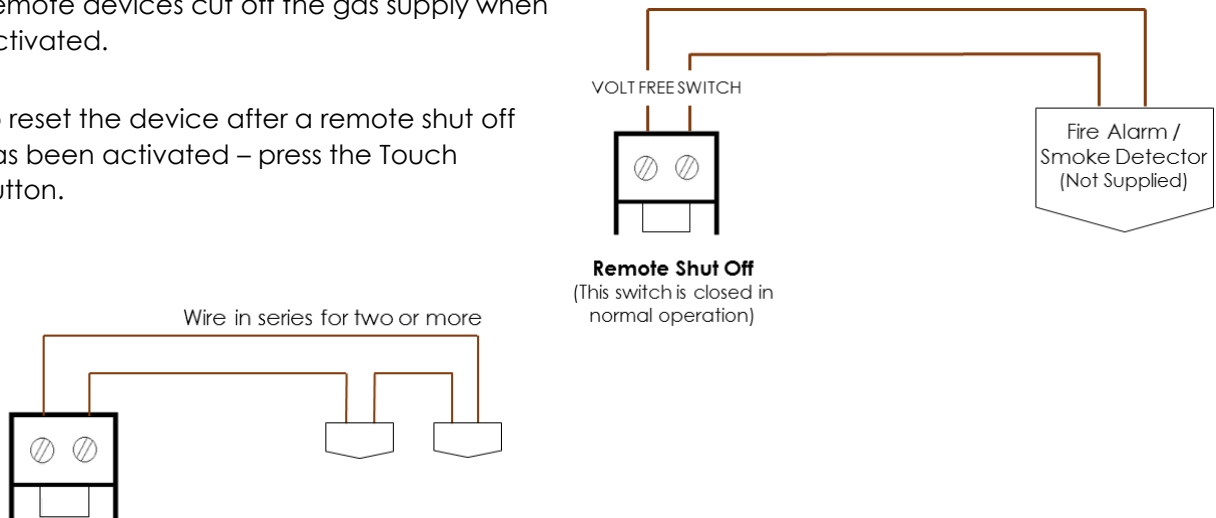

Audible Alarm Switch

The user can choose whether to have an audible alarm when dangerous gas levels are detected. The alarm will continuously sound – there are no provisions to silence the alarm, gas levels must drop to a safe level for the alarm to stop.

The buzzer measures approx. 65dB from a distance of 300mm/1ft (tested in quiet conditions). See section 'Board Overview'.

Auto Reset Switch

When the power is restored after a power loss, your device can either restart automatically or manually. See section 'Board Overview'.

Factory Set Condition

Buzzer / Audible Alarm	ON
Auto Reset	OFF

Trouble Shooting

Fault.	Possible Cause/Correction.
Device not responding.	o Incorrect wiring. Check Power/ Line In terminal.
End of Life message on screen	o Detector requires replacement – contact supplier,

Specification

Product:	Mini Merlin – CH4CO
Visual Indicators	Traffic Colour Gas Status / End of Life / Remote Shut Off
Display	1.8" TFT – Thin Film Transistor
Screen Brightness	Non- adjustable
Initial Stabilisation Time	60 Seconds approx.
Power Input Voltage	100-240V AC
Consumption	90mA Max (24V)
Accuracy @ 25°C / 77°F	± 5% of reading
Operating Temp	0 – 50°C 0-95%RH Non-Condensing
Gas Sensor Type	Methane: Semi-conducting Carbon Monoxide: Electromechanical
Gas Sensor Measuring Range	Methane: 500-10,000ppm Carbon Monoxide: 0-1000ppm
Gas Value Pre-Alarm	Methane: >8% LEL Carbon Monoxide: 20ppm
Gas Value Alarm	Methane: >10% LEL Carbon Monoxide: 20ppm after two (2) hours 50ppm after one (1) hour 100ppm after ten (10) minutes 300ppm after one (1) minute
Volt Free BMS relay output	0.5A switching current (resistive load)
Dimensions (mm)	95(W) x 140(H) x 60(D)
Weight	242g approx.

OPERATION

First Power Up

Supply 110-240vAC mains electrical supply to the [POWER/LINE IN] terminal, then press and hold the touch button on the front of the unit for 3 seconds. The device enters 'sensor stabilisation' phase for approximately 60 seconds – during this period the screen will display an 'initialisation' message indicating that the device is not yet ready for gas detection.

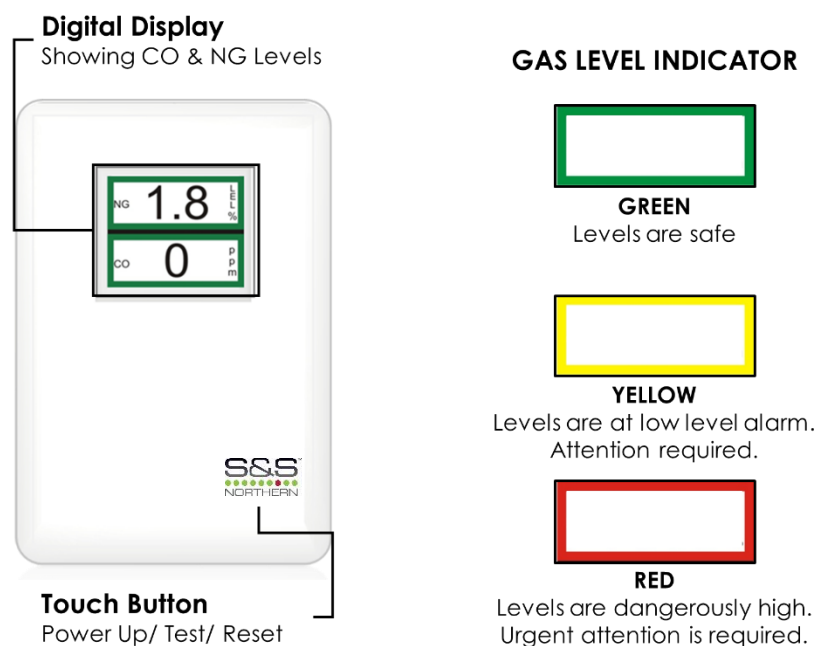

To switch your device off - remove or switch off the mains power supply.

Gas Level Display



At dangerous gas levels, the alarm will continuously sound if the buzzer dip-switch is ON.
There are no provisions to silence this alarm.
Only when gas levels are at a safe level will the audible alarm stop.

Audible Alarm Characteristics

-  **NO ALARM** – Gas concentration levels are safe. No alarm sound.
-  **PRE- ALARM** – Alarm will 'beep' every 15 seconds.
-  **ALARM** – Continuous alarm sound.

The alarm will only sound if the Buzzer is switched to ON.

Touch Button



POWER UP

Press and hold for 3 seconds when electrical supply is connected.

RESET

To reset after a gas alarm - press the touch button once.

TEST

Press and hold for 3 seconds when powered to test screen colouration, audible alarm and gas/BMS relay.

Remote Shut Off



If this device is connected to remote shut off devices (optional).

When activated, the digital display will indicate that it/they are activated and will shut off the gas supply if installed and configured to do so.

End of Life Indicator

This message indicates that the detector has reached its expected operational lifecycle. No gas levels will be displayed. Contact your supplier and replace the unit immediately.



The expected lifecycle may vary depending on environmental conditions.

Maintenance

Keep your detector in good working order follow these basic principles;

- DO carefully remove any accumulated dust from the outer enclosure once a month.
- NEVER use detergents or solvents to clean your device – this may permanently or temporarily damage the gas sensing elements.
- NEVER spray air fresheners, hair spray, paint or other aerosols near the device.
- NEVER paint the device. Paint will seal vents and interfere with the device.

High concentrations of alcohol found in many products may damage, deteriorate or affect the gas sensing elements – such as; wine; deodorants; stain removers; thinners etc.

Other gases and substances to avoid; Corrosives (i.e. chlorine & hydrogen chloride); Alkali metals; Basic or acidic compounds; Silicones; Tetraethyl lead; Halogens and halogenated compounds.

A detector may visually appear in good order, but its sensitivity can be inhibited by external factors. Regular 'bump tests' are important to make sure the detector is able to detect a release of gas as early as possible. A 'bump test' takes seconds and is often completed alongside a scheduled fire alarm test. We recommend this is done at least weekly to reduce the risk of a detector not performing, however the frequency should be determined from a risk assessment by the end user.



IMPORTANT WARNING STATEMENTS

The information contained within this manual should be referenced for typical installation and operation only.

For site specific requirements that may deviate from the information in this guide – contact your supplier.

The expected lifetime of gas sensor elements is 5 years upon initial power up. The device will display a message to indicate this time and should immediately be replaced.

It is recommended that this device be commissioned upon installation and serviced annually.

Do not apply lighter gas or other aerosols to the device – this will cause extreme damage.

High concentrations of alcohol/ ethanol found in many products may damage, deteriorate or affect the gas sensing elements – Avoid exposure near your device.

This device is designed to detect carbon monoxide and natural gas from any source of combustion. It is NOT designed to detect smoke, fire or other gases and should NOT be used as such.

This device provides early warning of the presence of methane or carbon monoxide, usually before a healthy adult would experience symptoms. This early warning is possible provided your alarm is located, installed and maintained as described in this guide.

This device requires a continual supply of electrical power – it will not work without power.

This device should not be used to substitute proper installation, use and/or maintenance of fuel burning appliances including appropriate ventilation and exhaust systems.

This device does not prevent methane or carbon monoxide from occurring or accumulating.

Actuation of your alarm indicates the presence of dangerous levels of Methane or CO. Seek fresh air supply and contact your local gas emergency service should you suspect a gas leak.

This unit may not fully safeguard individuals with specific medical conditions. If in doubt, consult a doctor/physician.

Your product should reach you in perfect condition, if you suspect it is damaged, contact your supplier.

Manufacturer's Warranty

Three (3) Year Warranty

Coverage: The manufacturer warrants to the original consumer purchaser, that this product will be free of defects in material and workmanship for a period of three (3) years from date of purchase or one (1) years for oxygen detectors.

The manufacturer's liability hereunder is limited to replacement of the product with repaired product at the discretion of the manufacture. This warranty is void if the product has been damaged by accident, unreasonable use, neglect, tampering or other causes not arising from defects in material or workmanship.

This warranty extends to the original consumer purchaser of the product only.

Disclaimers: Any implied warranties arising out of this sale, including but not limited to the implied warranties of description, merchantability and intended operational purpose, are limited in duration to the above warranty period. In no event shall the manufacturer be liable for loss of use of this product or for any indirect, special, incidental or consequential damages, or costs, or expenses incurred by the consumer or any other user of this product, whether due to a breach of contract, negligence, strict liability in tort or otherwise. The manufacturer shall have no liability for any personal injury, property damage or any special, incidental, contingent or consequential damage of any kind resulting from gas leakage, fire or explosion. This warranty does not affect your statutory rights.

Performance: During the above warranty period, your product will be replaced with a comparable product if the defective product is returned together with proof of purchase date. The replacement product will be in warranty for the remainder of the original warranty period or for six months – whichever is the greatest.



Information on waste disposal for consumers of electrical & electronic equipment. (EEE)

When this product has reached the end of its life it must be treated as Waste Electrical & Electronics Equipment (WEEE). Any WEEE marked products must not be mixed with general household waste, but kept separate for the treatment, recovery and recycling of the materials used.

Please contact your supplier or local authority for details of recycling schemes in your area.

Notes

Notes

Please pass this manual to the system owner / user.

Date of Installation:	
Installation Location:	
Organisation:	
Stamp/ Signature of the installer:	
Replacement Date:	

S&S Northern Head Office

Tel: +44(0) 1257 470 983
Fax: +44(0) 1257 471 937
www.snsnorthern.com
info@snsnorthern.com

South East Division

Tel: +44(0) 1702 291 725
Fax: +44(0) 1702 299 148
south@snsnorthern.com



S&S Northern is the owner of this document and reserves all rights of modification without prior notice.