

Merlin RS Series

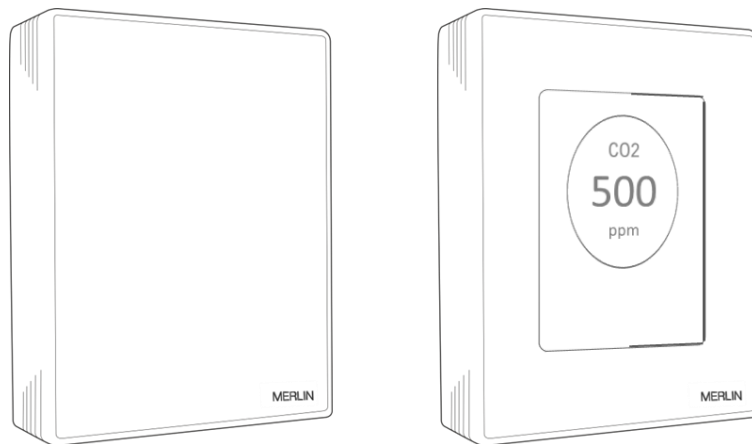

Safety & Health Monitoring Room Sensors



INSTALLATION & OPERATION

Please read these instructions carefully before use and retain for future reference.

These instructions can also be downloaded in electronic form on the product website.



[snsnorthern.com](https://www.snsnorthern.com)

















CONTENTS

| | |
|--|-----------|
| IMPORTANT INFORMATION | 3 |
| Manufacturer’s Warranty | 3 |
| INSTALLATION | 4 |
| General Information | 4 |
| Coverage | 4 |
| Positioning | 4 |
| Mounting Instructions | 5 |
| PCB Overview | 5 |
| Power Wiring | 6 |
| +10V Output Wiring | 6 |
| VFC Relay Wiring | 7 |
| Thermistor Wiring | 7 |
| RS-485 Wiring | 7 |
| Analog Configuration Switches | 8 |
| Digital RS-485 Configuration Switches | 8 |
| OPERATION | 9 |
| CO₂ Warning Levels | 9 |
| LED Indicator | 9 |
| 2.8” Screen Indicators | 9 |
| TECHNICAL SPECIFICATION | 10 |

IMPORTANT INFORMATION



Take extra care where this symbol is used to understand the nature of any potential hazards and how to avoid them.

-  Before any installation, use or maintenance, read this manual carefully.
-  This product is for Dry Environment Use only.
-  Avoid prolonged use in dusty environments.
-  The information contained within this manual should be referred to for typical installation and operation only.
-  For site specific requirements that may deviate from the information in this manual – contact your supplier.
-  If the equipment is used in a manner not specified by the manufacturer, the safety and protection provided by the equipment may be impaired.
-  Installation must be in accordance with recognised standards in the country concerned.
-  The PCB contains circuitry that can be damaged by static discharge.
-  When metal conduit is used provision shall be provided by the installer for bonding in accordance with the NFPA70.
-  Cables must be protected against mechanical damage.
-  This product is not designed to detect smoke, fire or other gases and should NOT be used as such.
-  This device requires a continual supply of electrical power – it will not work without power.
-  A switch or circuit breaker must be fitted, it must be accessible and marked as the disconnecting device.
-  This product should not be used to substitute appropriate ventilation and exhaust systems.
-  This product may not safeguard individuals with specific medical conditions. If in doubt, consult a doctor / physician.
-  Your product should reach you in perfect condition, if you suspect it is damaged, contact your supplier.

Manufacturer's Warranty

The manufacturer warrants to the original consumer purchaser, that this product will be free of defects in material and workmanship for a period of 3 Years from the date of purchase.

The manufacturer's liability hereunder is limited to replacement of the product with repaired product at the discretion of the manufacturer. This warranty is void if the product has been damaged by accident, unreasonable use, neglect, tampering or other causes not arising from defects in material or workmanship. This warranty extends to the original consumer purchaser of the product only. Any implied warranties arising out of this sale, including but not limited to the implied warranties of description, merchantability and intended operational purpose, are limited in duration to the above warranty period. In no event shall the manufacturer be liable for loss of use of this product or for any indirect, special, incidental, or consequential damages, or costs, or expenses incurred by the consumer or any other user of this product, whether due to a breach of contract, negligence, strict liability in tort or otherwise. The manufacturer shall have no liability for any personal injury, property damage or any special, incidental, contingent, or consequential damage of any kind resulting from gas leakage, fire, or explosion. This warranty does not affect your statutory rights. During the above warranty period, your product will be replaced with a comparable product if the defective product is returned together with proof of purchase date. The replacement product will be in warranty for the remainder of the original warranty period or for six months – whichever is the greatest.

Disposing of Electrical & Electronic Equipment (WEEE)

When this product has reached the end of its life it must be treated as Waste Electrical & Electronics Equipment (WEEE). Any WEEE marked products must not be mixed with general household waste, but kept separate for the treatment, recovery and recycling of the materials used. Please contact your supplier or local authority for details of recycling schemes in your area.

INSTALLATION

General Information

 **Failure to observe the following may cause injury to persons and/or property.**

The RS detector series is to be installed in non-classified, non-hazardous, permanent locations and is intended to continuously monitor the ambient air for carbon dioxide (CO₂) levels, temperature (°C) and relative humidity (rH%) providing an analogue and/or digital representation of the levels.

Designed for all areas being directly connected to low or mains voltage supply, e.g., residential, public, commercial, and light industrial environments, which support the following outputs:

- **Analog:** 3x 0-10V signals for CO₂ (PPM), Temperature (°C) and Humidity (% Relative).
- **Digital:** RS-485 Modbus RTU or BACnet MS/TP communication protocols.
- **Relay:** VFC (CO₂): 1x SPST 70mA Max.
- **Thermistor:** 10K3 output for 3rd party temperature monitoring.

The equipment can operate as a standalone unit, be connected to a Merlin control panel or to other 3rd party devices capable of accepting digital and/or analogue signals, such as a Building Management System (BMS).

Installation must be carried out by a licenced and insured contractor, installed, and located in positions determined by those who have knowledge of CO₂ dispersion, process plant systems and any equipment involved. Seek advice where necessary, in consultation with both safety and electrical engineering personnel.

Consider air flow patterns within the area, RS detectors must be installed in the correct orientation as per the manufacturer's specification, and ease of access should be accounted for to allow for any forms of maintenance throughout its operational life. For installations in North America, the National Electrical Code (NEC) should be strictly observed, and all appropriate local and national regulations should be observed.

Coverage

There are no official figures of area coverage for a detector; however, 50 feet (15.2 metres) per detector or 7,580 square feet (704.2 square metres) per detector is a reasonable general guide therefore multiple detectors may be required to adequately monitor and protect property and/or persons.

Positioning

 **Position at a location with minimum noise, vibration, and environmental variation.**

Recommended heights may vary based on air flow and temperature conditions in addition to the proposed application and location.

Generally, the installation height of a monitor for CO₂ would be **breathing zone – 3-5ft from ground level**. Observe the following also.

- The possible damage caused by natural events e.g., rain, flooding, falling debris.
- Ease of access to the RS monitor.
- Any regulation/standard/code that locations are bound by.

Mounting Instructions

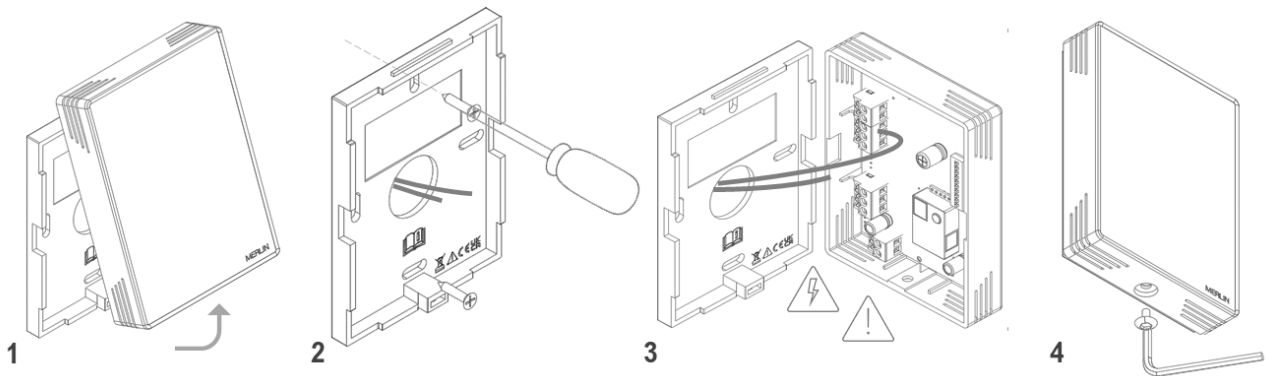

1. **Remove the front cover** by removing the screw underneath the housing using an M3 socket wrench.
2. **Mark mounting holes** ensuring surface is flat to avoid distortion. Using the backplate, mark points and drill 0.2" (5mm) hole, insert plugs and use screws provided.
3. **Cable entry** is provided via rear 12.5mm (1/2") cut-out. Execute the mounting and connections.
NOTE: Terminals are pluggable type for ease.
4. **Secure the front cover** by aligning the top and then securing the M2 screw in place.

PCB Overview

- ⚠ All Class 2 wiring is to be installed within flexible tubing to maintain segregation between circuits.
- ⚠ Wiring of different circuits shall be separated by means of routing, clamping or barrier.
- ⚠ Strip cables as short as possible ensuring bare wires, e.g., wire shields, do not contact with the circuit board.

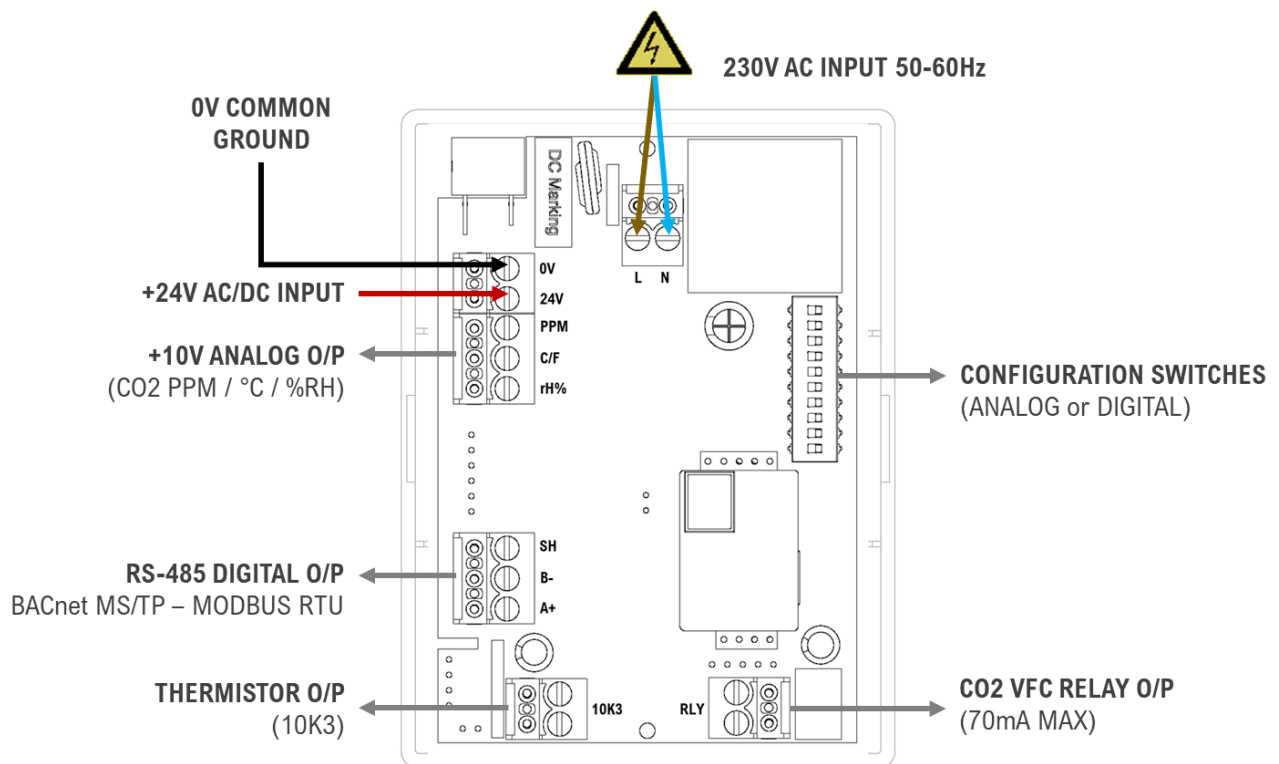

DISCLAIMER: For reference purposes only. All Diagrams and Connections depend on model.

Power Wiring

Consider voltage drops due to cable resistance and strip the cables as short as possible ensuring bare wires, e.g., wire shields, do not contact with the circuit board (risk of short-circuit).

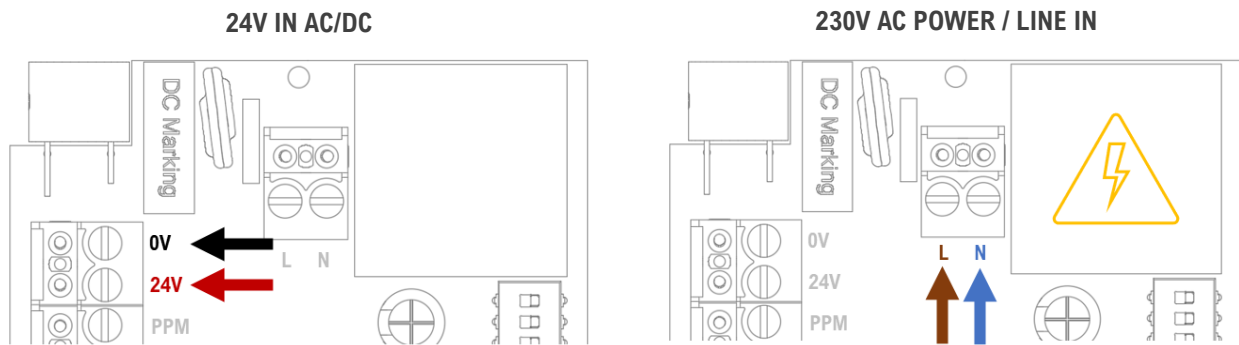

+10V Output Wiring

A linear +10V output is normally used to regulate external fan speed controllers (supplied separately).

The RS features a configurable 0/2-10V linear output for CO₂ (PPM), Temperature (C/F°) and Humidity (rH%). During normal operation, the output of the device is proportional to the values.

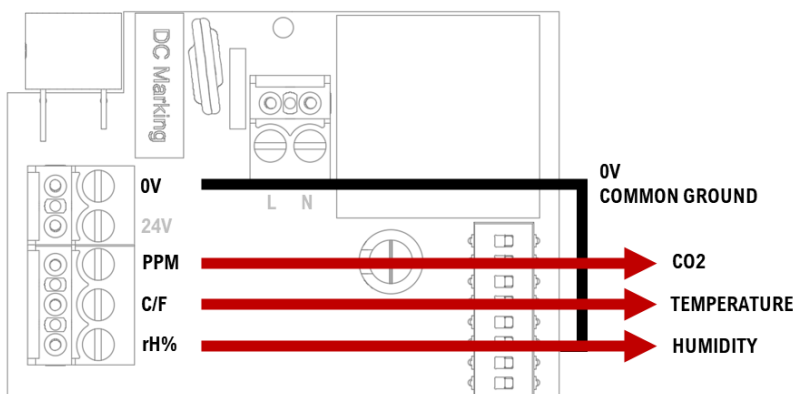

In normal operation, output levels are proportional to the gas level as shown below.

| O/P | CO ₂ Range | | Temperature | Humidity | 0-10V O/P | 2-10V O/P |
|------|-----------------------|----------|-------------|----------|-----------|-----------|
| 0% | *0ppm | | 0°C | 0%rH | 0V | 2V |
| 10% | 200 | 500 | 5 | 10 | 1V | 2.8V |
| 20% | 400 | 1,000 | 10 | 20 | 2V | 3.6V |
| 30% | 600 | 1,500 | 15 | 30 | 3V | 4.4V |
| 40% | 800 | 2,000 | 20 | 40 | 4V | 5.2V |
| 50% | 1,000 | 2,500 | 25 | 50 | 5V | 6.0V |
| 60% | 1,200 | 3,000 | 30 | 60 | 6V | 6.8V |
| 70% | 1,400 | 3,500 | 35 | 70 | 7V | 7.6V |
| 80% | 1,600 | 4,000 | 40 | 80 | 8V | 8.4V |
| 90% | 1,800 | 4,500 | 45 | 90 | 9V | 9.2V |
| 100% | 2,000ppm | 5,000ppm | 50°C | 100 %rH | 10V | 10V |

* The average concentration of CO₂ in air is around 400ppm or 0.4%

VFC Relay Wiring

This is a dry contact/volt free connection to a BMS (building management system) or central control panel to send an alarm signal upon the defined CO2 level. This terminal can be used in conjunction with other external relays that affect other devices, and controls such as purge fans, audible alarms, strobe/beacons etc.

As a factory set condition, the relay is Normally Closed when the device is energised and in normal operation (fail safe), ensuring relays are triggered upon a power failure.

Thermistor Wiring

This 2-way terminal provides an output for a **BETATHERM, 10K3A1B** NTC type thermistor fitted to the PCB. Other thermistor types are available, contact your supplier for more information.

RS-485 Wiring

- ⚠ Ensure the equipment is configured in a single bus topology, connecting multiple buses in parallel or branching multiple units from the main bus, may introduce impedance mismatches, reflections and/or signal distortions.
- ⚠ Ensure A+/B- signal polarity is maintained throughout the network.
- ⚠ Connect GND wire to 0V common grounding terminal.

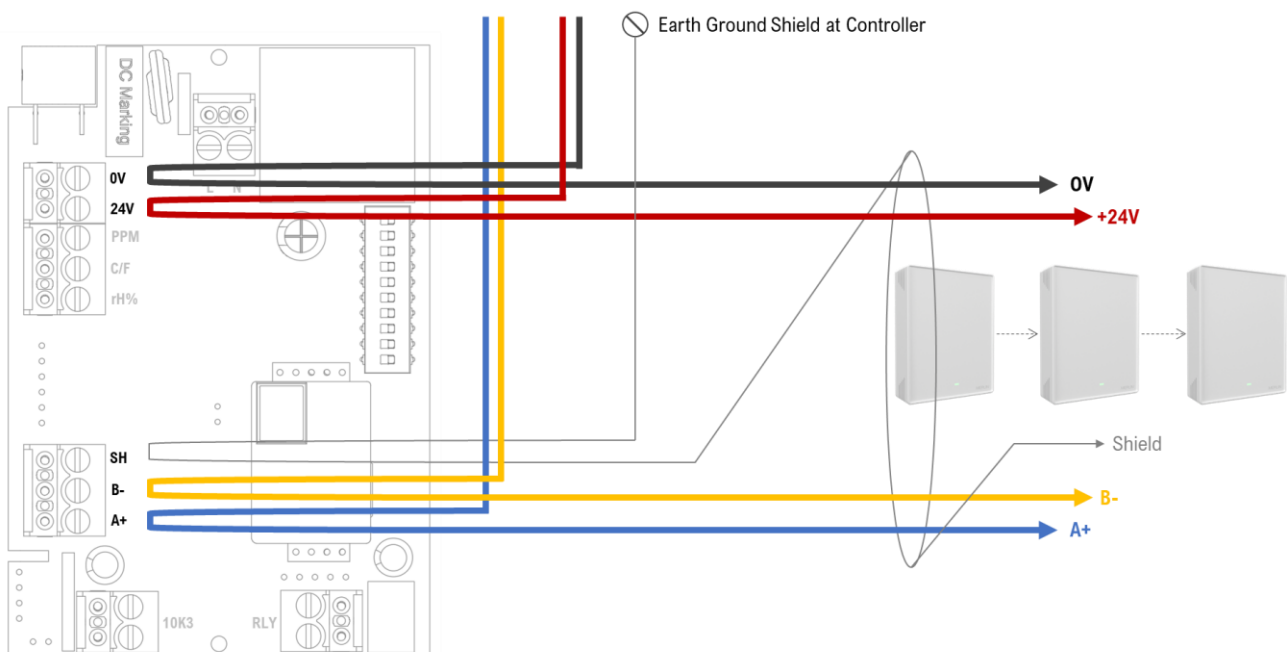

Daisy chain wires running to additional RS sensors – 127 sensors max per cable run. First and last device in bus requires a termination resistor. Use EOL switch to terminate RS sensor. Recommended 3-core, 2 twisted pair + ground, shielded cable with 120 Ω characteristic impedance.

Shield terminal [SH] is used to maintain shield line only. Shield is cut and taped on last device.

Consider voltage drops due to cable resistance for long distances/large networks. Cable specifications ultimately determine the distance the sensors can be mounted away from a control panel or power supply. Strip cables as short as possible.

See **RS BACnet or Modbus Functionality** Document for more information and parameterization.

Analog Configuration Switches

| LABEL | ACTION | OPTION | DEFAULT |
|------------|---------------------------------|---|------------------------------|
| EOL | NOT USED | | |
| 1 | (CO2) Range* | ON: 0-2000 ppm OFF: 0-5000 ppm | OFF 5000ppm |
| 2 | (CO2) Low Level Warning | ON: 1000 ppm OFF: 1500 ppm | OFF 1500ppm |
| 4 | (CO2) High Level Warning | ON: 1500 ppm OFF: 2800 ppm | OFF 2800ppm |
| 8 | (CO2) VFC Relay Position | ON: NO (Normally Open) OFF: NC (Normally Closed) | OFF (NC) Fail Safe |
| 16 | (CO2) VFC Relay Switches at | ON: 1000 ppm OFF: 4500 ppm | OFF 4500ppm |
| 32 | (CO2) +10V Output Linear Scale | ON: 2-10V OFF: 0-10V | OFF 0-10V |
| 64 | (TH**) +10V Output Linear Scale | ON: 2-10V OFF: 0-10V | OFF 0-10V |
| B1 | Temperature Value | OFF: °C ON: °F | OFF °C |
| B2 | NOT USED | | |

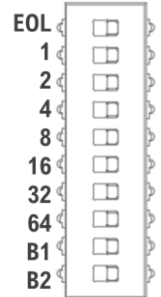

* The average concentration of CO2 in air is around 400ppm or 0.4%

** TH = Temperature and Humidity

Digital RS-485 Configuration Switches

| LABEL | ACTION | OPTION | DEFAULT |
|------------|-----------------------------------|---|--|
| EOL | END OF LINE TERMINATION RESISTOR. | | OFF |
| 1 | NETWORK ADDRESS | Address achieved by adding binary switch values together. 4 ON + 16 ON = ADDRESS 20 8 ON + 32 ON + 1 ON = ADDRESS 41 Address Max: 127 | OFF (Address 0) |
| 2 | | | |
| 4 | | | |
| 8 | | | |
| 16 | | | |
| 32 | | | |
| 64 | | | |
| B1 | BAUD RATE SELECTION | Baud rates achieved by configuring B1 and B2 switches. B1 OFF / B2 OFF = 9600 B1 OFF / B2 ON = 38400 B1 ON / B2 OFF = 19200 B1 ON / B2 ON = (76800 - BACnet) (57600 - Modbus) | B1 OFF B2 OFF (9600) |
| B2 | | | |

 **If the address value conflicts with another device, neither device will be able to communicate.**

OPERATION

CO₂ Warning Levels

- ⚠ Before leaving the device for normal operation, check configuration for proper settings.
- ⚠ After connecting power, the device will enter a warm-up period to allow the device to establish connections and sensor elements to stabilize before a valid reading/output.
- ⚠ There are no warnings/alarms for Temperature or Humidity levels.
- ⚠ CO₂ warning levels will depend on configuration at install.

PPM = Parts Per Million

| CO ₂ Range | OK | Low CO ₂ Warning | High CO ₂ Warning |
|----------------------------|------------------------|-----------------------------|------------------------------|
| 400 - 5000ppm (Default) | < 1499ppm (Default) | 1500 – 2799ppm (Default) | > 2800ppm (Default) |

LED Indicator

- **GREEN** = CO₂ Level OK / Power Supplied
- **YELLOW** = CO₂ Level Warning (LOW)
- **RED** = CO₂ Level Warning (HIGH)

2.8" Screen Indicators

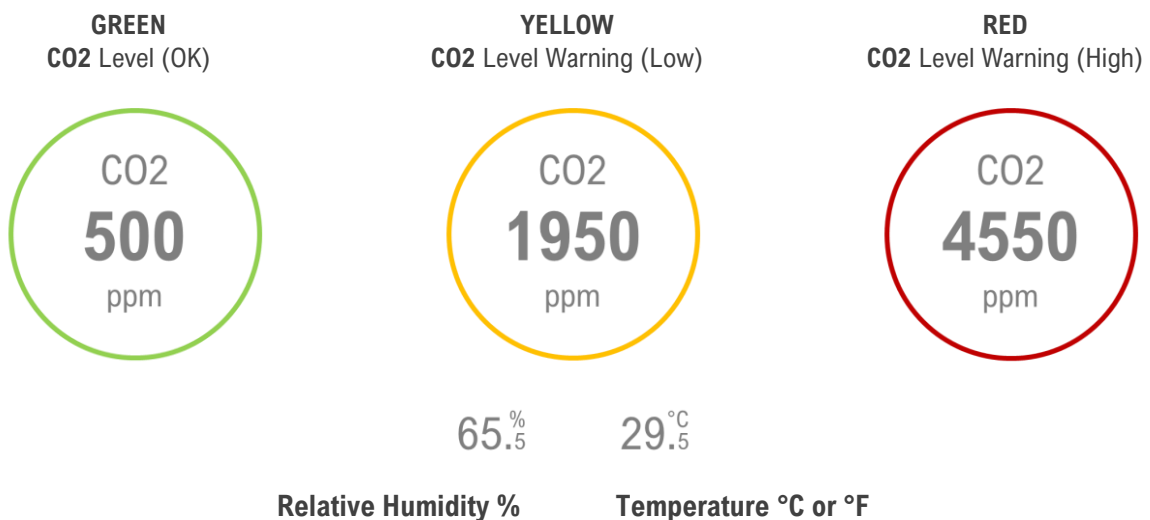

TECHNICAL SPECIFICATION

| | | |
|--|--|--|
| Mechanical | Mounting | Wall Mounted |
| | Entry | 1" / 25.4mm DIA Rear Entry |
| | Size (W x H x D) | 86 x 114 x 35mm (Low Profile RS - 86 x 114 x 25mm) |
| | Weight (Max) | 0.164Kg max |
| | Enclosure | ABS UL Flame retardant – IP40 |
| Electrical | 24V AC/DC Power Rating | 12-24VDC (11-32 VDC) / 24VAC, (20-27 VAC) 50-60Hz |
| | 230VAC Power Rating | Nominal 230VAC, (90-250V AC), 50-60Hz |
| | Internal Fuse | Resettable PPTC 240VAC, 400mA |
| | Communication | 127 units max |
| | Power Consumption Max | 5W Max |
| Environmental | Operating Temperature | -10 to 50°C |
| | Storage | 10-30°C / 0 to 95% RH |
| | Humidity | 0 to 95% RH (continuous) non-condensing. |
| | Atmospheric Pressure | 80 to 110Pa |
| | Altitude | <2000m |
| | Installation Cat (230V Voltage) | II (Class 2) Pollution Degree 2 |
| Installation Cat (24V Voltage) | III (Class 3) Pollution Degree 2 | |
| I/Os | Analog Outputs | 3x Linear 0-10V/2-10V CO2, Temperature & Humidity. Thermistor (10K3) |
| | Digital Networks | BACnet MS/TP / MODBUS RTU (Parity: None Data bit: 8bit Stop bit: 1) |
| | Relay Outputs | 1x SPST 70mA |
| | Thermistor | 10K3A1B For alternative Thermistors, contact your supplier |
| | Cable Spec | Power |
| Analog Output | | 1.0 – 2.5mm ₂ max |
| Digital Output | | 1.0 – 2.5 mm ₂ twisted pair + ground, shielded cable with 120Ω characteristic impedance. |
| Relays | | 1.0 – 2.5mm ₂ max |
| User Interface | Language | English |
| | Optional Display | 2.8" TFT |
| | Optional LED Indication | Green: Power (OK) Yellow: Warning (Pre-Alarm) Red: Danger (Alarm) |
| Conformance | Safety | BS 61010-1 (CE / UKCA) |
| | Electromagnetic Compatibility | BS 50270 (CE / UKCA) |
| | Other (Applied or Considered) | IGEM/UP/11 BS 50543 |
| Sensing | | |
| CO2 (ppm) | Temperature (°C) | Humidity (%RH) |
| Sampling: Diffusion Type NDIR Indication Range: 400 – 5000ppm Response: t90 <120s Calibration: ABC Logic Self Calibration - Warm Up Time: ~1 Minute Accuracy: 5% FS @ 25°C Lifespan: >10 Years Resolution: 1ppm | Fully Calibrated Normal Indication Range: 0-50°C Response: t63% @ 25°C ~20s Typical Excellent long term stability Strong anti-interference Warm Up Time: ~1 minute Accuracy: ±0.5° @ 10-45°C Resolution: 0.1° | Fully Calibrated Indication Range: 0-100% RH Quick Response: t63% @ 25°C ~8s Excellent long term stability Strong anti-interference Warm Up Time: ~1 minute Accuracy: ±2% @ 15-30°C (20-90%RH) Resolution: 0.1% |

Page intentionally left blank.

Please pass this manual to the system owner / user.

| | |
|-----------------------------------|--|
| Date of Installation: | |
| Installation Location: | |
| Organisation: | |
| Stamp/Signature of the installer: | |

We recommend all S&S equipment be commissioned by competent/trained engineers to ensure correct installation and operation. We strongly recommend the response and alarm signals are tested and validated once installed. This will ensure the equipment performs as intended and is free from any unforeseen damage caused by transit/installation.

Every effort is made to ensure the accuracy of this document; however, S&S Northern can assume no responsibility for any errors or omissions in this document or their consequences. S&S Northern would greatly appreciate being informed of any errors or omissions that may be found in the content of this document. For information not covered in this document, or if there is a requirement to send comments/corrections, please contact S&S Northern using the contact details given below.

S&S Northern Limited

www.snsnorthern.com

S&S Northern Head Office

Tel: +44 (0) 1257 470983

info@snsnorthern.com

S&S Southeast Division

Tel: +44 (0) 1702 291725

south@snsnorthern.com



S&S Northern is the owner of this document and reserves all rights of modification without prior notice.