MERLIN



Refrigerant Gas Detector: X

R134a / R32 / R410a



INSTALLATION & OPERATION INSTRUCTIONS

Please read these instructions carefully and retain for future use.

These instructions can be downloaded in electronic form on the product website.



snsnorthern.com



















Contents

Safety Related Information	3
Manufacturer's Warranty	3
Installation	4
Introduction.....	4
Mounting Instructions	5
Circuit Board Overview.....	6
Wiring to GDPX+ or GDP2X Controller	7
Network Address Switches	8
Termination Resistor	8
Wiring to GDP2 or GDP4 Controller	8
Wiring to Merlin 'S' Controllers	9
Audible Alarm.....	9
Factory Set Condition	9
Commissioning	10
Overview	10
Operation	11
Initial Power Up - Start Up Sequence.....	11
Colour Indications	11
Alarm List.....	11
Care & Maintenance	12
Overview	12
Circuit testing	12
Service Reminder Message	12
Typical Sensor Life Expectancy.....	13
Disposing of Electrical & Electronic Equipment (WEEE).....	13
System Bump Test	13
Overview	13
Bump Test (Gas Response Check) Procedure	14
Reset Service Message.....	14
Specifications	15

Safety Related Information



Where this symbol is used, the manual must be consulted to understand the nature of any potential hazards and how to avoid them.

-  Before any installation, use or maintenance read this manual carefully.
-  Dry Environment Use Only
-  The information contained within this manual should be referenced for typical installation and operation only.
-  For site specific requirements that may deviate from the information in this guide – contact your supplier.
-  If the equipment is used in a manner not specified by the manufacturer, the safety and protection provided by the equipment may be impaired.
-  Installation must be in accordance with recognised standards in the country concerned.
-  When metal conduit is used provision shall be provided by the installer for bonding in accordance with the NFPA70.
-  This product is designed for indoor operation only unless used in conjunction with a weatherproof cover.
-  Cables must be protected against mechanical damage.
-  The internal fuse should be replaced only with the same type. Anti-surge fuse 3.15A 250Vac 5x20.
-  This product is not designed to detect smoke, fire or other gases and should NOT be used as such.
-  This device requires a continual supply of electrical power – it will not work without power.
-  A switch or circuit breaker must be fitted, it must be accessible and marked as the disconnecting device!
-  This device should not be used to substitute proper installation, use and / or maintenance of fuel burning appliances including appropriate ventilation and exhaust systems.
-  Seek fresh air supply and contact your local gas emergency service should you suspect a gas leak.
-  This device may not fully safeguard individuals with specific medical conditions. If in doubt, consult a doctor.
-  Any parts that form part of the connections/installation must have a minimum fire-retardant rating of UL 94V-2!
-  Your product should reach you in perfect condition, if you suspect it is damaged, contact your supplier.

Manufacturer's Warranty

The manufacturer warrants to the original consumer purchaser, that this product will be free of defects in material and workmanship for a period of 3 years from the date of purchase.

The manufacturer's liability hereunder is limited to replacement of the product with repaired product at the discretion of the manufacturer. This warranty is void if the product has been damaged by accident, unreasonable use, neglect, tampering or other causes not arising from defects in material or workmanship. This warranty extends to the original consumer purchaser of the product only. Any implied warranties arising out of this sale, including but not limited to the implied warranties of description, merchantability and intended operational purpose, are limited in duration to the above warranty period. In no event shall the manufacturer be liable for loss of use of this product or for any indirect, special, incidental, or consequential damages, or costs, or expenses incurred by the consumer or any other user of this product, whether due to a breach of contract, negligence, strict liability in tort or otherwise. The manufacturer shall have no liability for any personal injury, property damage or any special, incidental, contingent, or consequential damage of any kind resulting from gas leakage, fire, or explosion. This warranty does not affect your statutory rights. During the above warranty period, your product will be replaced with a comparable product if the defective product is returned together with proof of purchase date. The replacement product will be in warranty for the remainder of the original warranty period or for six months – whichever is the greatest.

Installation

Introduction

 **Failure to observe the following may cause injury to persons and/or property.**

General

Installation must be carried out by a licenced and insured contractor and installed in areas at risk of gas leaks e.g., near boilers, valves, or meters, located in positions determined by those who have knowledge of gas dispersion, the process plant system and equipment involved, and in consultation with both safety and electrical engineering personnel.

Final positioning of gas detectors should be indicated by the characteristics of the gas being detected and other environmental factors. Seek advice where necessary. Take in to account the design of the air flow patterns within the area, sensors should be installed in the correct orientation as per the manufacturer's specification, and ease of access should be accounted for to allow for any forms of maintenance throughout its operational life. For installations in North America, the National Electrical Code (NEC) should be strictly observed, and all appropriate local and national regulations should be observed.

Coverage

There are no official figures of area coverage for a gas detector; however, 50 feet (15.2 metres) per detector or 7,580 square feet (704.2 square metres) per detector is a reasonable general guide therefore multiple detectors may be required to adequately protect property and persons.

Positioning

There are no specific standards governing gas detector locations (unlike fire detection systems); there are, however, general guidance documents. The most relevant being *IEC 60079-29-2: Explosive Atmospheres – Part 29: Gas detectors – Selection, installation, use and maintenance of detectors for flammable gases and oxygen*. Much of what it covers is also relevant to toxic gas & oxygen monitoring equipment.

Recommended heights may vary based on air flow and temperature conditions in addition to the proposed application, location, and target gas. Sensors should be located near identified sources of a potential gas leaks/pockets where gas/air could quickly accumulate and areas of identified consequential risk.

The composition of the target gas and its density relative to air are used as the basis for the recommended height of sensors. Generally, the installation height of a sensor for a heavy gas (e.g., propane/LPG) would be close to the lowest point in the area, and for a light gas (such as methane) would be close to the highest point in the area. These typical positions may vary based on air flow and temperature conditions in addition to the proposed application and location – this is particularly apparent with oxygen depletion sensors, and the target gas that they are used for.

Target Gas

Typical Install Height

Refrigerant: R134a / 410a / 32

As close to the ground level.

If you are installing oxygen detectors - consider the density of gas for its application and position the detector accordingly i.e., ground level for high-density gases. Observe the following also.

- The possible damage caused by natural events e.g., rain or flooding.
- Ease of access to the gas detector for functional testing and servicing.
- How gas may behave due to natural or forced air currents.
- Any regulation/standard/code that locations are bound by.

The detectors are designed around a centralised control panel of which the location also needs to be considered. The control panel should be located away from the area that it is monitoring and accessible is for both status observation and alarm purposes.

Mounting Instructions

⚠ Position at a location with minimum noise, vibration, and environmental variation.

1. Carefully remove the front cover from the unit by using an M3 socket wrench.
2. Using the rear base - mark mounting holes to the wall or align with an appropriate gang/pattress box.
3. Fixing straight to wall – drill 0.2” (5mm) hole, insert plugs and use the four screws (No.4 Pozi) provided.
4. There are pre-fractured areas for cable entry on the rear of the base and pilot holes positioned on the top and bottom of the enclosure suitable for entry points up to ¾” (20mm).
5. After executing the mounting/connections – secure the front cover with all M4 bolts and insert security caps provided. Make a note of the installation date on the label located on the side of the unit.

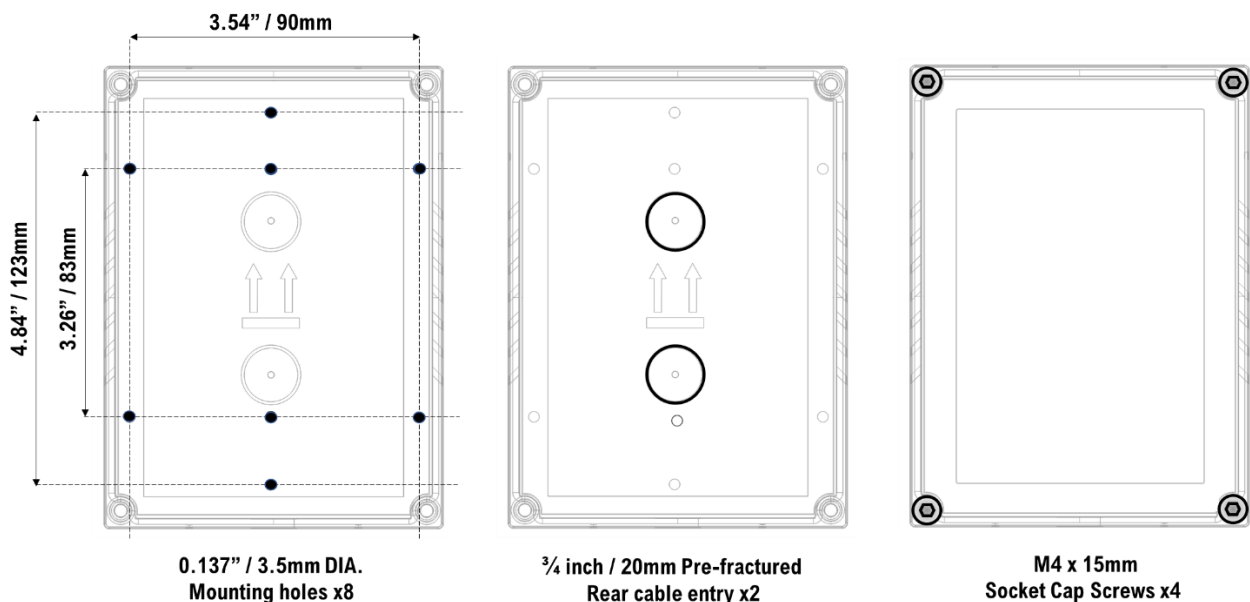

We recommend all Merlin safety and health monitoring equipment is commissioned by a competent/trained engineer to ensure correct installation and operation.

Contact us for more information.

Circuit Board Overview

- ⚠ Be careful when creating access for cables – Damage to circuit boards will void any warranty.
- ⚠ Any damage attempting to remove the circuit board parts may void any warranty.
- ⚠ Detectors must be earthed/grounded for electrical safety and to limit the effects of EMC or R/F interference.
- ⚠ For modbus communication, a shielded cable is used throughout the chain of devices.

Description	Label	Termination
Digital Merlin GDP-X Compatible	Power	+
		-
	Data	D+
		D-
		Shield Wire
Analog Merlin GDP Compatible	Power	+
		-
	Current Loop	C/L
BMS Relay Volt Free 0.5A @ 240VAC	BMS	NC
		COM
		NO

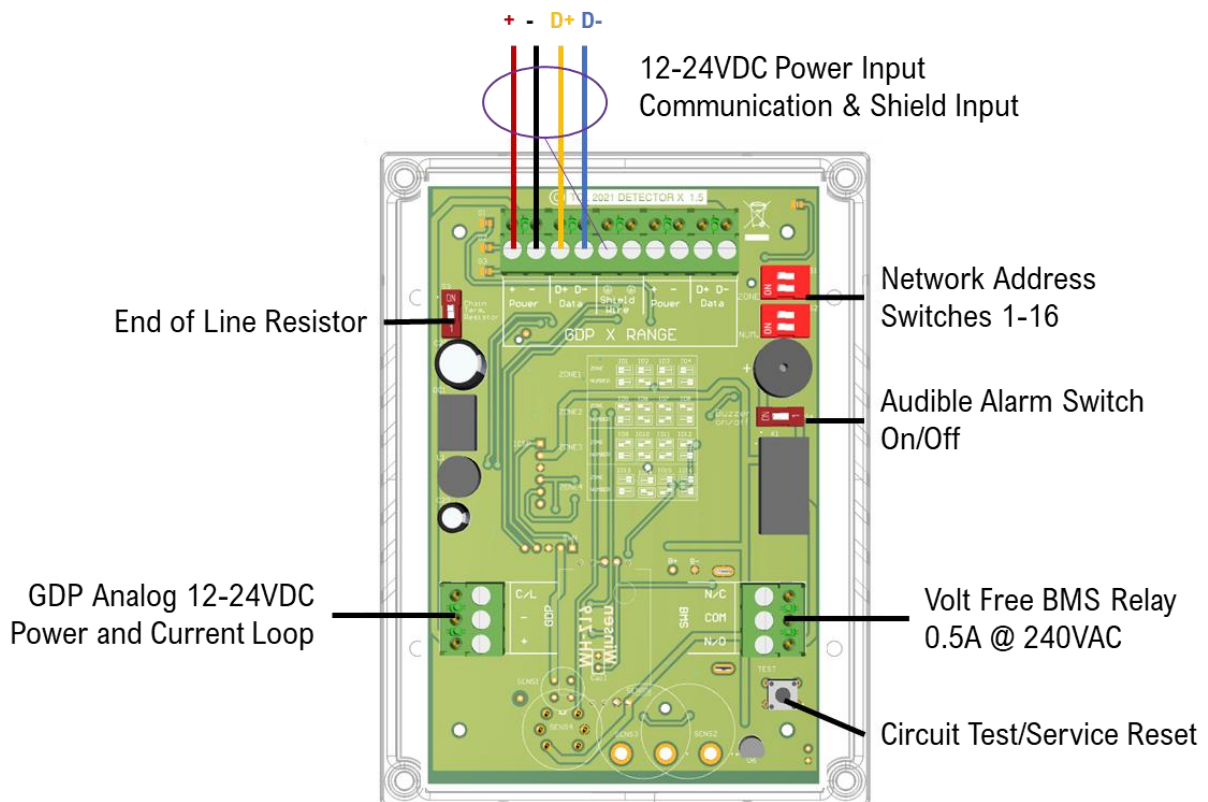

Terminal blocks are plug/socket type and may be removed to ease wiring.

Wiring to GDPX+ or GDP2X Controller

- ⚠ The detector must be earthed/grounded for electrical safety and limit the effects of R/F & EMC interference.
- ⚠ Where cable runs may exceed 100 yards from one control panel – Contact your supplier.
- ⚠ Ensure the 120-ohm termination resistance switch is turned on at each end of a cable run.

Daisy chain wires running to additional detectors.

The first and last device in the bus chain require a termination resistor.

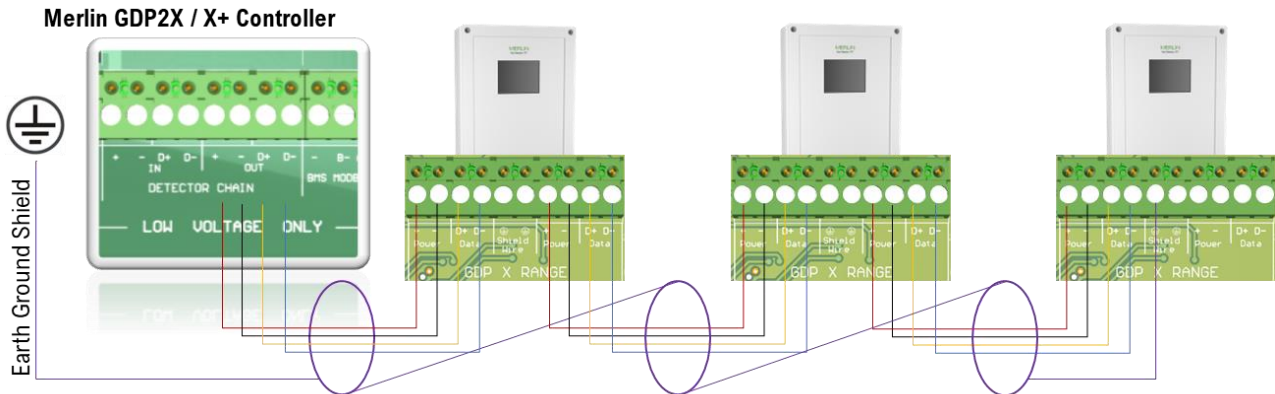

[SHIELD WIRE] terminals should be used for terminating the end of a daisy chain and shield wire screwed into any earth terminal on the control panel. Twist the shield wire to avoid stray shield wires.

A shielded and twisted 2 or 4 core cable is used to wire the MODBUS terminals [D+ & D-]. The shielding can be of 2 types: braided [mesh of thin conducting wires] or foil (consisting of a thin sheet of metal covering the twisted wires). One example of such cable is BELDEN 3082A. Any cable with similar characteristics can be used to connect all the devices together. If you are encountering noise or irregular problems with a bus link, the problem is likely related to grounding, incorrect shielding or wiring mains power cables next to data cables.

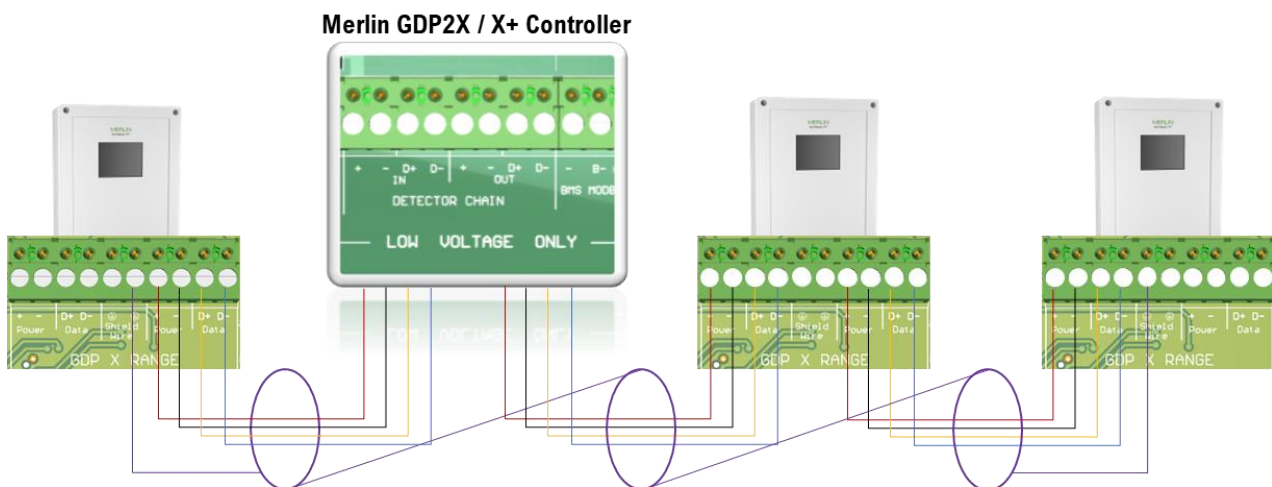

Reversing the [D+] and [D-] connections of any device can lead to the whole system to stop working owing to reverse polarity found on the terminals.

Network Address Switches

-  **We recommend a plan, map and/or marking the detector enclosures detailing ID and location!**
-  **ID Switches must be configured for each detector connected to receive and display accurate data!**

When wiring multiple detectors, it is important to identify each detector installed for the control panel to receive and display accurate data corresponding with the correct device.

The ID configuration diagram is printed onto detector boards for quick reference as shown opposite. All detectors are factory set to ID1.

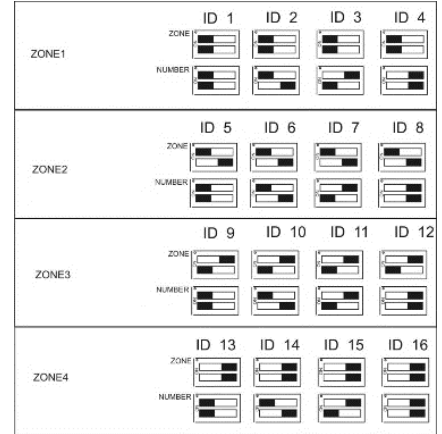
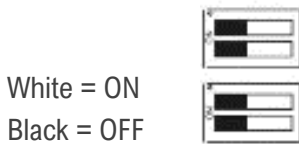

Termination Resistor

Signal communication issues may occur where the bus length is too long, high baud rates are used, or signal reflections are occurring. To avoid this, terminating at each end of a chain may help the quality of the data signal by turning on the 120-ohm terminal resistor switch. If a split chain is used, terminate the last detector in each chain. If a single chain is used, terminate the first device (controller) and last device (Detector).

Wiring to GDP2 or GDP4 Controller

Power is supplied to a detector via the GDP terminal [+ / -] and using the panel [GAS DETECTION ZONE] terminal. If you are using a GDP panel you will need to use the detector [C/L] terminal as an alarm relay.

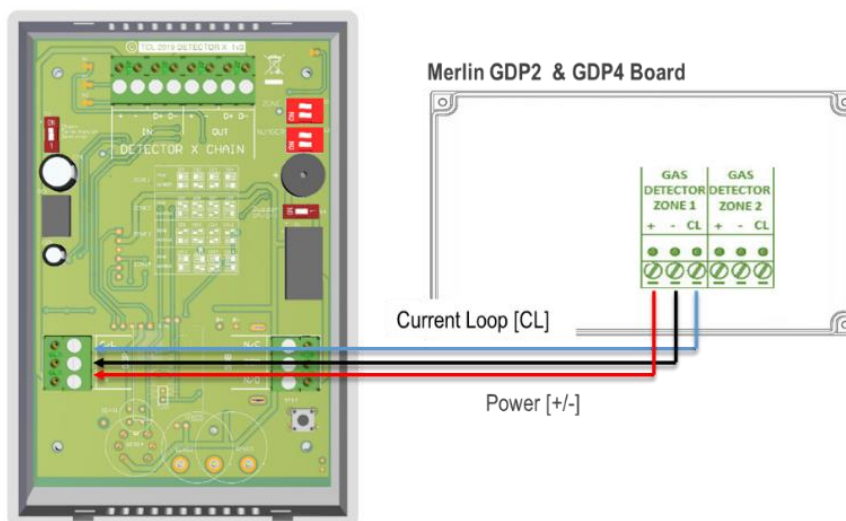

BMS terminals can be used in conjunction with other external relays that affect other devices and controls such as purge fans or audible alarms etc.

Wiring to Merlin 'S' Controllers

Power is supplied to a detector via the GDP terminal [+ / -] and using the 'S' panel [GAS DETECTOR] terminal [+ / -]. For a BMS alarm relay use [COM] and [NC] on the detector and the [open/close] switch terminal on the panel. BMS are volt free/dry contact connections.

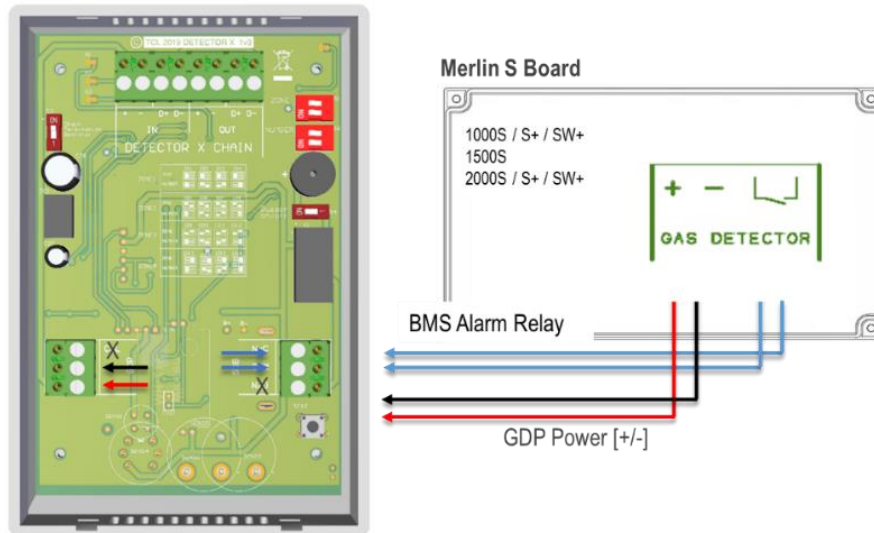

A relay will change state when in alarm or when gas is detected. BMS terminals can be used in conjunction with other external relays that affect other devices and controls such as purge fans and audible alarms etc.

Audible Alarm

There is a switch on the detector board identified as [Buzzer On/Off].

The detector can be configured to have an audible alarm or not when gas levels reach the alarm set points.

The alarm will continuously sound – there are no provisions to silence the alarm, gas levels must drop to a safe value for the alarm to stop.

Factory Set Condition

Buzzer On/Off Switch	ON
Chain Termination Resistor	OFF
Detector ID Switches	ID 1

Commissioning

Overview

 **Merlin sensors are designed to operate in a wide range of harsh environments and conditions. However, it is important that exposure to high concentrations of solvent vapours is avoided, both during storage and operation.**

We recommend all Merlin gas detection equipment be commissioned by competent/trained engineers to ensure correct installation and operation. This will ensure the safety equipment performs as intended and free from unforeseen damage caused by transit and handling/installation etc.

Merlin gas detectors are factory calibrated when shipped under ambient conditions, however, we strongly recommend the detectors response and alarm signals are tested and validated once installed and subsequently every 6-18 months thereafter to retain optimum safety.

During Commissioning

- Check installation, mounting, cable entry, position.
- Check the power supply voltage and indicator.
- Check/perform calibration.
- Check indications for proper operation.
- Check buzzer and relay operation.
- Check signal transmission to the BMS/central controller, where appropriate.

Regular maintenance and calibration of the sensors by trained technicians is strongly recommended. Inspections and services must be documented and executed at regular intervals.

The frequency must be determined and observed by the person responsible for the gas warning system according to all regulatory, code and legal requirements. The inspection interval is normally 6 to 18 months to retain optimum safety. The date for the next maintenance must be affixed to the equipment sensor.

Contact us for more information for qualified commissioning, maintenance, decommissioning and repair services.

Operation

Initial Power Up - Start Up Sequence

On connecting power, the detector enters 'sensor stabilisation' phase for approximately 60 seconds – during this period the screen will display an 'initialisation' message indicating that the device is not yet ready for gas detection. After the sensor has stabilised – the screen will display;

- Target gas.
- Target gas value.
- Target gas measurement (parts per million or % LEL).
- Unique detector serial/batch number.
- Configured ID number.

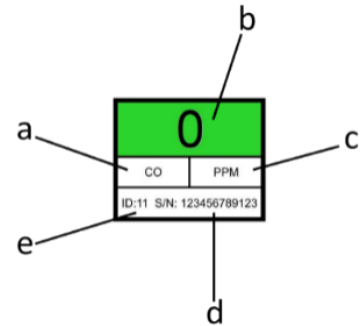

Colour Indications



Alarm List

Refrigerant	Pre-Alarm (Low)	Buzzer	Alarm (High)	Buzzer
R134a Safety Class A1 (ppm)	▲ 175	No	▲ 1000 (10s Delay)	Yes Continuous Sound
R410a Safety Class A1 (ppm)	▲ 350			
R32 Safety Class A2L (ppm)				

Care & Maintenance

Overview

⚠ Merlin sensors are designed to operate in a wide range of harsh environments and conditions. However, it is important that exposure to high concentrations of solvent vapours is avoided, both during storage and operation.

Regular maintenance and calibration of the sensors by trained technicians is recommended. Inspections and services must be documented and executed at regular intervals.

The frequency must be determined and observed by the person responsible for the gas warning system according to all regulatory, code and legal requirements. The inspection interval is normally 6 to 18 months to retain optimum safety. The date for the next maintenance must be affixed to the equipment sensor.

Interval	Function
During Commissioning	Check installation, orientation, mounting, cable entry & wiring. Check indications for proper operation. Check buzzer and relay operation. Check signal transmission to the BMS/central controller, where appropriate.
Every 6-18 Months**	Inspection by trained service personnel.

** **Typical frequency.** This can vary by sensor type, application and national or local regulation/code.

Circuit testing

- ⚠ Access to the interior of the detector, when carrying out any work, must be conducted by a competent person!**
- ⚠ This circuit test does not check the gas-sensing element itself!**

When the test button on the circuit board is pressed and held the detector will simulate an open circuit to ensure configured systems, outputs, alarms, indications, and other external devices operate as intended in response to gas. When the test button is released – the test sequence will terminate and return to normal operation.



Service Reminder Message



A service screen will intermittently flash every 30 seconds after one year of operation. The annual message reminder will begin after five (5) hours of continuous power irrespective of whether the system is then, used intermittently. The detector will still operate as intended during this time.

Depending on the application and environmental factors, a service (bump test) can be conducted at a higher frequency determined by the end user but must be executed by a competent person.

Typical Sensor Life Expectancy

-  **The End-of-Life message is approximate from the first five (5) hours of continuous power!**
-  **The End of Life will depend on the type of gas your detector is targeting and may vary depending on its application and environmental conditions such as the frequency of exposure to the target gas, poisons, or inhibitors!**

The typical life of a gas detector depends on its application and intended target gas, in addition the operational life can be prolonged if the system and equipment is installed and maintained in accordance the instructions stated within this manual.

At the end of its predicted operational life – the detector will display an ‘End of Life’ screen. This message indicates that the detector has reached its expected operational lifecycle and no gas levels are displayed. You must contact your supplier immediately for replacement.

Sensor Type	Long Term Stability	Lifetime**
NDIR – Non dispersing Infrared	+3% FS per annum	>5 Years

**** Normal Use.** *The typical life of a sensor depends on its application and intended target gas, in addition the operational life can be prolonged if the system and equipment is installed and maintained in accordance with these instructions.*



Disposing of Electrical & Electronic Equipment (WEEE)

When this product has reached the end of its life it must be treated as Waste Electrical & Electronics Equipment (WEEE). Any WEEE marked products must not be mixed with general household waste, but kept separate for the treatment, recovery and recycling of the materials used.

Please contact your supplier or local authority for details of recycling schemes in your area.

System Bump Test

Overview

-  **For more help and advice on bump testing – contact us.**
-  **Always give at least five (5) minutes between testing the same unit or until gas has fully dispersed!**

A bump test is a live test of the system to verify that the detector responds to gas and all connected alarm devices, BMS, etc. are operating accordingly. It is recommended that all involved persons are informed about the test and certain alarms might have to be inhibited (e.g., shutdown valves, notification of authorities, etc.).

If the system fails to operate as intended in an alarm state, the gas detector must not be used until a full inspection and service has been conducted. A detector may visually appear in good working order, but its sensitivity and accuracy can be inhibited by external factors. Dust, humidity, temperature fluctuations, cleaning products, contaminants, exposure to its target gas or sensor drift (ageing) can cause a decline in sensitivity, accuracy, and eventual failure.

Bump Test (Gas Response Check) Procedure

Activate Controller Service Mode – GDP2X & GDPX+ only.

This will inhibit all alarms/outputs and signals for fifteen (15) minutes!

If you are testing all actuation of alarms/outputs and signals, please proceed to Step 2.

1. Access service mode by pressing the S&S logo on the controller (home screen logo only).
2. The screen will display a service message prompt.
3. Press Yes. (Note: All alarm signals/outputs will be inhibited for fifteen (15) minutes).
4. Proceed to test gas detectors.
5. Upon completion – exit service mode by pressing the ‘Exit’ button on screen.

Apply Gas to Detector

1. Ensure you have the correct gas for the device type prior to application.
2. Screw and seal the regulator/valve into the gas cylinder outlet.
3. Once sealed, the regulator pressure gauge will indicate cylinder pressure.
4. Offer up the applicator hose/cone to the vents or sensor.
5. Alternatively, enclose the device and apply gas i.e., in an airtight bag or container.
6. Open the valve/regulator to allow the gas to be delivered at a pre-set flow rate.
7. Wait for the device to enter alarm status and energise configured outputs/relays.
8. At this point...
9. Remove applicator hose/ cone and turn the gas cylinder regulator/valve off.
10. Wait for the device to return to normal.
11. Reset the system.
12. Record your test details. There is a provision for this in your control panel manual.

End.

Reset Service Message

⚠ It is recommended to bump test detector(s) prior to resetting the service reminder message.

1. Carefully remove the detector cover.
2. Tap the ‘test button’ 3 times within 2 seconds.
3. The service message on screen will reset.
4. Carefully replace the back cover.

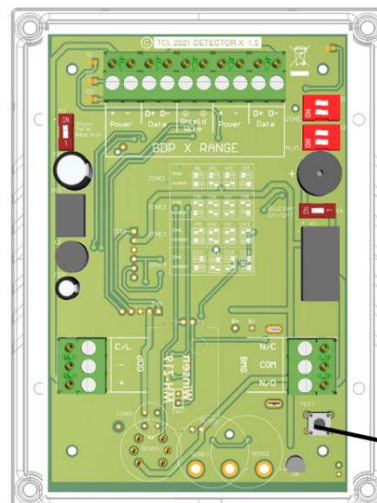

Service Message Reset
Tap 3 times

Specifications

General							
Model:	Merlin Gas Detector X						
Target Gases:	Refrigerant: R134a / R32 / R410a						
Size: (H x W x D)	5.95 x 4.37 x 1.97" (151 x 111 x 50mm)						
Housing Material:	ABS - PA765						
Mounting:	Safe Zone - Indoor use - Wall Mounted						
Weight:	10.6oz (0.3kg)						
User Interface							
Display:	1.8" TFT						
Screen Brightness:	Non-Adjustable						
Visual Indicators:	TFT visual. Green: Normal; Yellow: Pre-Alarm; Red: Alarm						
Audible Alarm:	>70dB @ 3.28ft (1m). Quiet conditions.						
Language:	English						
Power Supply							
Power Consumption:	90mA Max @ 24vdc						
DC Power:	12-32 VDC - Nominal 24 VDC						
Internal Fuse:	None						
Equipment							
Overvoltage Category:	III						
Pollution Degree:	3						
I/O							
Dry Contact / Volt Free Relay:	(Normally Closed / Common / Normally Open) 1A @ 120VAC / 0.5A @ 240VAC						
Environmental							
Ingress Protection:	Not Formally Evaluated						
Operating:	-10 ~ 50°C / 14 ~ 122°F 30 ~ 80% RH (non-condensing)						
Storage:	-25 ~ 50°C / -13~122F° up to 95% RH (non-condensing)						
Altitude Rating:	2000m						
Wiring							
Typical	#15AWG Power Pair; #18AWG Data Pair-Tinned copper.						
Compliance							
Electromagnetic Compatibility and Electrical Safety	BS/IEC/EN 61010-1 EMC EN 50270						
Other							
Communication	RS485 MODBUS RTU						
Sensor Specification							
Gas Sensor	Indicating Range ppm	Steps	Response (t90)	Recovery (t10)	Alarm: 1 (Pre alarm warning)	Alarm: 2	*EOL (Years)
NDIR							
R134a	175-5000	25	<60s	<60s	▲ 175 ppm	▲ 1000 ppm (10s Delay)	5
R410a	350-10000	50			▲ 350 ppm		
R32							

PPM Concentration in Parts per Million ▲ Rising Alarm *EOL Expected Operational Life

Installation Details

Please pass this manual to the system owner / user.

Date of Installation:	
Installation Location:	
Organisation:	
Stamp/Signature of the installer:	



We recommend all Merlin gas detection equipment be commissioned by competent/trained engineers to ensure correct installation and operation. The Merlin range of gas detectors are calibrated when manufactured, however, we strongly recommend the detectors response and alarm signals are tested and validated once installed. This will ensure the equipment performs as intended and is free from any unforeseen damage caused by transit/installation.

Every effort is made to ensure the accuracy of this document; however, S&S can assume no responsibility for any errors or omissions in this document or their consequences. S&S would greatly appreciate being informed of any errors or omissions that may be found in the content of this document. For information not covered in this document, or if there is a requirement to send comments/corrections, please contact S&S using the contact details given below.

Find out more.

S&S Northern Limited
www.snsnorthern.com

S&S Northern Head Office
 +44(0) 1257 470 983
 info@snsnorthern.com

Southeast Division
 +44(0) 1702 291 725
 south@snsnorthern.com



S&S Northern Limited is the owner of this document and reserves all rights of modification without prior notice.