

Merlin IAQ Monitor



Indoor Air Quality Monitor



INSTALLATION & OPERATION

Please read these instructions carefully before use and retain for future reference.

These instructions can also be downloaded in electronic form on the product website.

snsnorthern.com

















CONTENTS

IMPORTANT INFORMATION	3
Manufacturer’s Warranty	3
INSTALLATION	4
General Information	4
Coverage	5
Positioning	5
Mounting Instructions	5
PCB Overview	5
Power Wiring	6
RS-485 Wiring	6
Digital RS-485 Configuration Switches	8
OPERATION	9
Air Score	9
IAQ Parameters	9
Optional Features	10
Settings Page	10
CALIBRATION & MAINTENANCE	12
Calibration	12
Maintenance	12
TECHNICAL SPECIFICATION	15

IMPORTANT INFORMATION



Take extra care where this symbol is used to understand the nature of any potential hazards and how to avoid them.

-  Before any installation, use or maintenance, read this manual carefully.
-  This product is for Dry Environment Use only.
-  Avoid prolonged use in dusty environments.
-  The information contained within this manual should be referred to for typical installation and operation only.
-  For site specific requirements that may deviate from the information in this manual – contact your supplier.
-  If the equipment is used in a manner not specified by the manufacturer, the safety and protection provided by the equipment may be impaired.
-  Installation must be in accordance with recognised standards in the country concerned.
-  The PCB contains circuitry that can be damaged by static discharge.
-  When metal conduit is used provision shall be provided by the installer for bonding in accordance with the NFPA70.
-  Cables must be protected against mechanical damage.
-  This product is not designed to detect smoke, fire or other gases and should NOT be used as such.
-  This device requires a continual supply of electrical power – it will not work without power.
-  A switch or circuit breaker must be fitted, it must be accessible and marked as the disconnecting device.
-  This product should not be used to substitute appropriate ventilation and exhaust systems.
-  This product may not safeguard individuals with specific medical conditions. If in doubt, consult a doctor / physician.
-  Your product should reach you in perfect condition, if you suspect it is damaged, contact your supplier.

Manufacturer's Warranty

The manufacturer warrants to the original consumer purchaser, that this product will be free of defects in material and workmanship for a period of 3 Years from the date of purchase.

The manufacturer's liability hereunder is limited to replacement of the product with repaired product at the discretion of the manufacturer. This warranty is void if the product has been damaged by accident, unreasonable use, neglect, tampering or other causes not arising from defects in material or workmanship. This warranty extends to the original consumer purchaser of the product only. Any implied warranties arising out of this sale, including but not limited to the implied warranties of description, merchantability and intended operational purpose, are limited in duration to the above warranty period. In no event shall the manufacturer be liable for loss of use of this product or for any indirect, special, incidental, or consequential damages, or costs, or expenses incurred by the consumer or any other user of this product, whether due to a breach of contract, negligence, strict liability in tort or otherwise. The manufacturer shall have no liability for any personal injury, property damage or any special, incidental, contingent, or consequential damage of any kind resulting from gas leakage, fire, or explosion. This warranty does not affect your statutory rights. During the above warranty period, your product will be replaced with a comparable product if the defective product is returned together with proof of purchase date. The replacement product will be in warranty for the remainder of the original warranty period or for six months – whichever is the greatest.

Disposing of Electrical & Electronic Equipment (WEEE)

When this product has reached the end of its life it must be treated as Waste Electrical & Electronics Equipment (WEEE). Any WEEE marked products must not be mixed with general household waste, but kept separate for the treatment, recovery and recycling of the materials used. Please contact your supplier or local authority for details of recycling schemes in your area.

INSTALLATION

General Information

⚠ **Failure to observe the following may cause injury to persons and/or property.**

Intended for indoor commercial and public areas to monitor multiple local environmental and air quality factors; temperature (°C), relative humidity (rH%), carbon dioxide (CO₂), Particulate Matter levels (PM_{2.5}) and Total Volatile Organic Compounds (TVOC).

Monitors should be installed in areas where good air quality is paramount, located in positions determined by those who have knowledge of air dispersion, the process plant system and equipment involved, and in consultation with both safety and electrical engineering personnel. Take in to account the design of the airflow patterns within the area. Monitors must be installed in the correct orientation, as recommended, and ease of access should be accounted for to allow for any forms of maintenance throughout its operating life.

The **Air Quality Score** is based on the measured values of; CO₂ (Carbon Dioxide), Particulate Matter and TVOC. The Score is calculated and indicated in real time, in addition averages are calculated over one (1) and eight (8) hour time periods. Scores within a space can vary throughout the day due to changes in number of occupants, activities being performed or ventilation rates in the space. The opening and closing of doors and windows can also have an effect. It is best to position monitors at head height and away from windows, doors, or air supply openings.

Monitors that are positioned too close to people may give a misleadingly high reading due to the CO₂ in exhaled breath. Monitors should therefore be positioned at least 500mm away from room occupants.

Instantaneous or 'snapshot' score readings can be misleading, therefore reviewing data should be taken throughout the day, week, or month, depending on what is happening within the space. The frequency of measurements should be sufficient to ensure that changes in the use of the room or space throughout the day are represented in the readings.

Designed for all areas being directly connected to mains or 24v low voltage supply, e.g., residential, public, commercial, and light industrial environments.

The equipment can operate as a standalone unit or be connected to other 3rd party devices capable of accepting digital and/or analogue signals, such as a Building Management System (BMS). The monitor supports the following outputs:

- **Digital:** RS-485 Modbus RTU or BACnet MS/TP communication protocols.

Installation must be carried out by a licenced and insured contractor, installed, and located in positions determined by those who have knowledge of CO₂ dispersion, process plant systems and any equipment involved. Seek advice where necessary, in consultation with both safety and electrical engineering personnel.

Consider air flow patterns within the area, the detectors must be installed in the correct orientation as per the manufacturer's specification, and ease of access should be accounted for to allow for any forms of maintenance throughout its operational life. For installations in North America, the National Electrical Code (NEC) should be strictly observed, and all appropriate local and national regulations should be observed.

Coverage

It is the responsibility of the user to determine the required coverage of monitors; however, 5,400 square feet (500 square metres) per detector is a reasonable general guide therefore multiple detectors may be required to adequately monitor and protect property and/or persons. Guidelines for the monitor coverage can be found in the latest WELL building standards.

Positioning

⚠ Position at a location with minimum noise, vibration, and environmental variation.

Recommended heights may vary based on air flow and temperature conditions in addition to the proposed application and location.

Generally, the installation height of a monitor for CO₂ would be **breathing zone – 3-5ft from ground level**.

Observe the following guidelines also.

- The possible damage caused by natural events e.g., rain, flooding, falling debris.
- Ease of access to the monitor.
- Any regulation/standard/code that locations are bound by.
- Monitors must be at least 1 m [3.3 ft] away from: doors, windows, air supply/exhaust outlets, air purifiers, or other potential influences (e.g., humidifiers, cleaning supplies, printers and photocopiers). To the extent possible, sampling points should be at least 5 m [16.4 ft] from exterior doors.
- • Additionally, monitors must be at least 1 m [3.3 ft] away from: direct sunlight, mechanical system supply outlets, fans, heaters or any other significant source of heat or cold.

Mounting Instructions

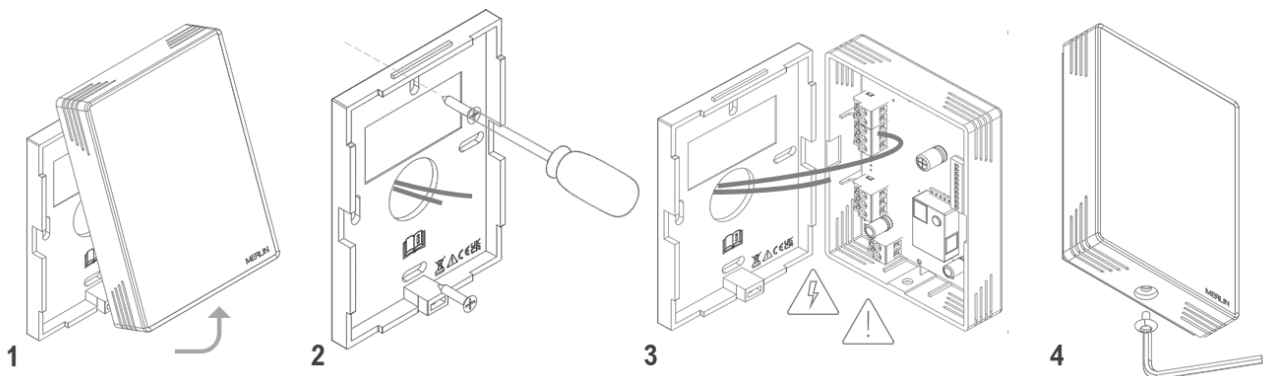

1. **Remove the front cover** by removing the screw underneath the housing using an M3 socket wrench.
2. **Mark mounting holes** ensuring surface is flat to avoid distortion. Using the backplate, mark points and drill 0.2" (5mm) hole, insert plugs and use screws provided.
3. **Cable entry** is provided via rear 25.4mm (1") cut-out. Execute the mounting and connections.
NOTE: Terminals are pluggable type for ease.
4. **Secure the front cover** by aligning the top and then securing the M2 screw in place.

PCB Overview

⚠ All Class 2 wiring is to be installed within flexible tubing to maintain segregation between circuits.

⚠ Wiring of different circuits shall be separated by means of routing, clamping or barrier.

⚠ Strip cables as short as possible ensuring bare wires, e.g., wire shields, do not contact with the circuit board.

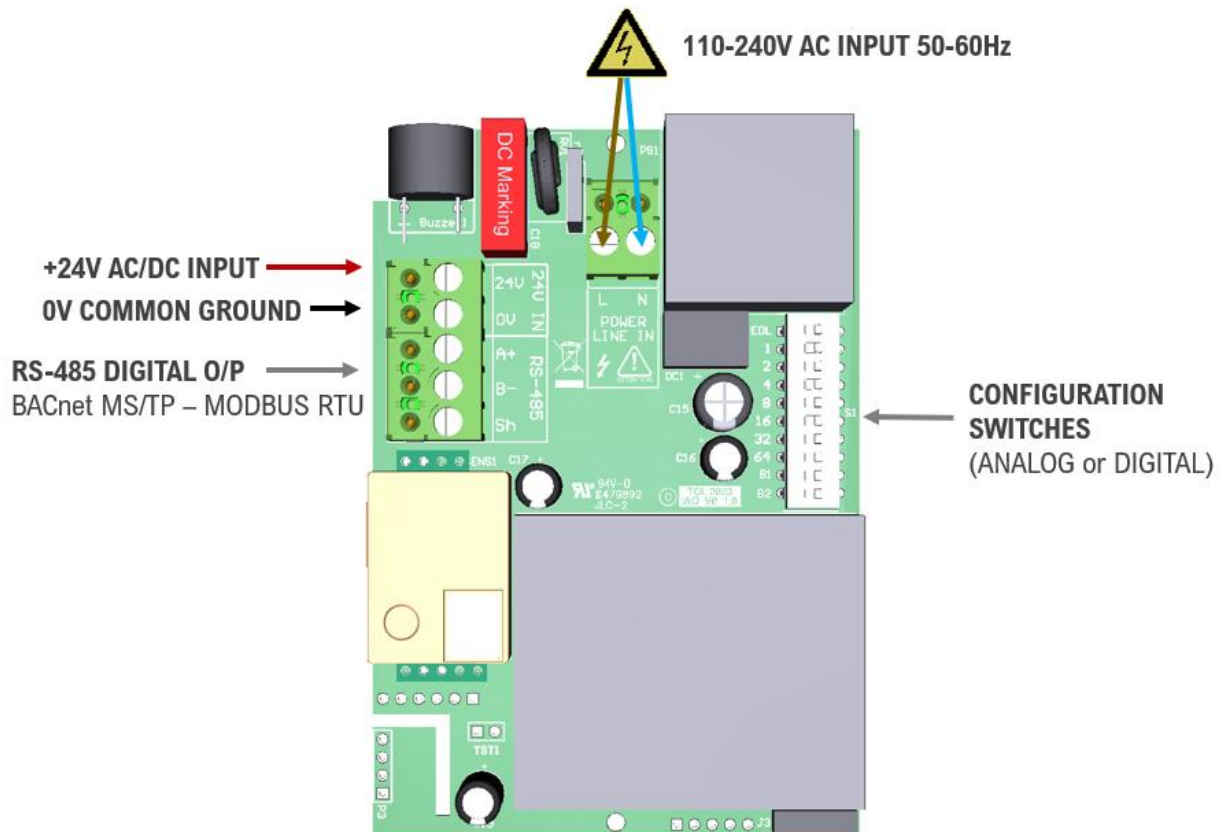

DISCLAIMER: For reference purposes only. All Diagrams and Connections depend on model.

Power Wiring

Consider voltage drops due to cable resistance and strip the cables as short as possible ensuring bare wires, e.g., wire shields, do not contact with the circuit board (risk of short-circuit).

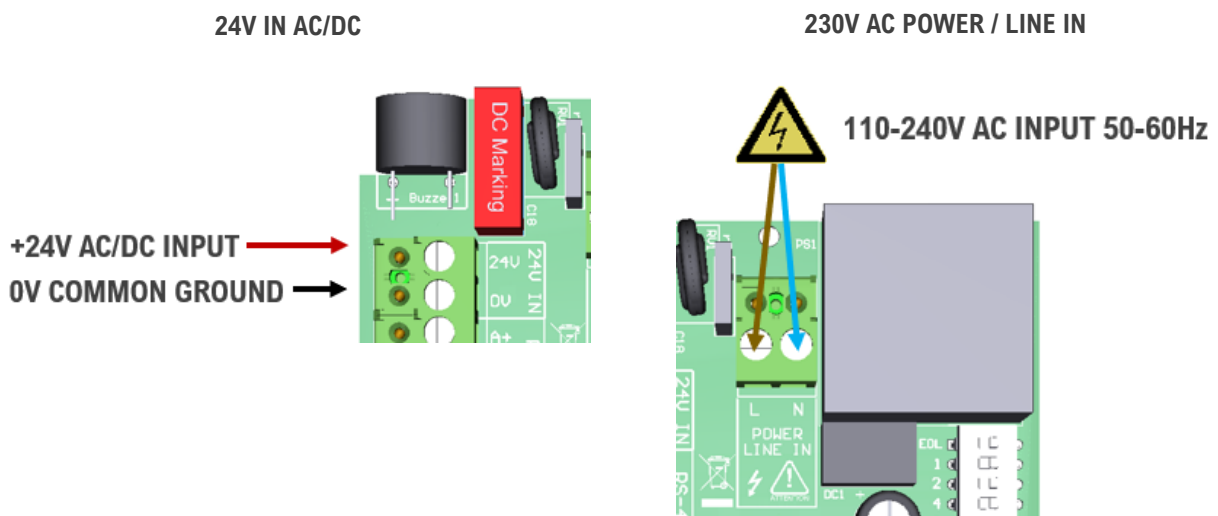

RS-485 Wiring

- ⚠ Ensure the equipment is configured in a single bus topology, connecting multiple buses in parallel or branching multiple units from the main bus, may introduce impedance mismatches, reflections and/or signal distortions.**
- ⚠ Ensure A+/B- signal polarity is maintained throughout the network.**

⚠ Connect GND wire to 0V common grounding terminal.

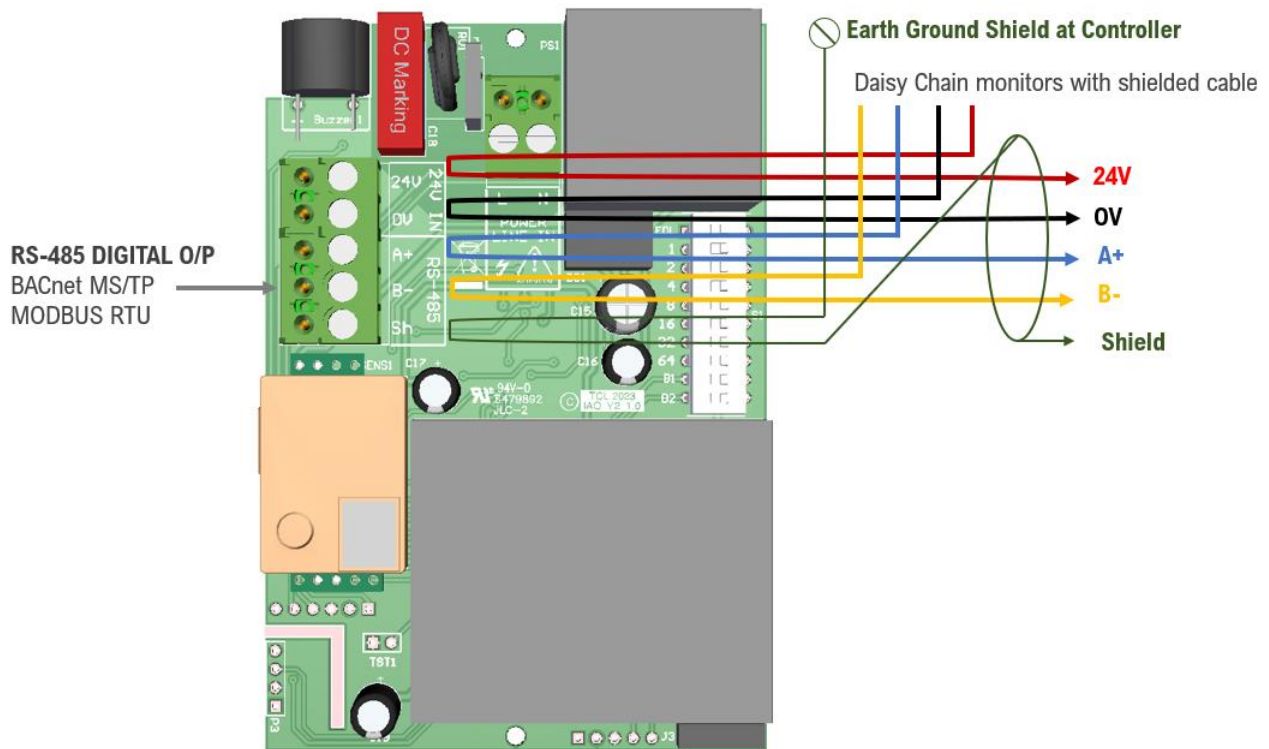

Daisy chain wires running to additional monitors – 127 sensors max per cable run. First and last device in bus requires a termination resistor. Use EOL switch to terminate IAQ sensor. Recommended 3-core, 2 twisted pair + ground, shielded cable with 120 Ω characteristic impedance.

Shield terminal [SH] is used to maintain shield line only. Shield is cut and taped on last device.

Consider voltage drops due to cable resistance for long distances/large networks. Cable specifications ultimately determine the distance the sensors can be mounted away from a control panel or power supply. Strip cables as short as possible.

See **IAQ BACnet or Modbus Functionality** Document for more information and parameterization.

Digital RS-485 Configuration Switches

LABEL	ACTION	OPTION	DEFAULT
EOL		END OF LINE TERMINATION RESISTOR.	OFF
1	NETWORK ADDRESS	Address achieved by adding binary switch values together. 4 ON + 16 ON = ADDRESS 20 8 ON + 32 ON + 1 ON = ADDRESS 41 Address Max: 127	OFF (Address 0)
2			
4			
8			
16			
32			
64			
B1	BAUD RATE SELECTION	Baud rates achieved by configuring B1 and B2 switches. B1 OFF / B2 OFF = 9600 B1 OFF / B2 ON = 38400 B1 ON / B2 OFF = 19200 B1 ON / B2 ON = (76800 - BACnet) (57600 - Modbus)	B1 OFF B2 OFF (9600)
B2			

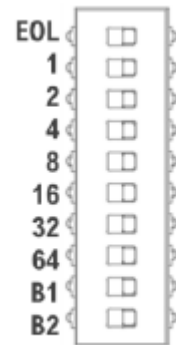

⚠ If the address value conflicts with another device, neither device will be able to communicate.

Pre-Requisites:

Connection to building management systems in conjunction with a plant / Unitary controller.

OPERATION

Air Score

The air quality score allows users and facility managers to review a numerical score out of one hundred, this indicates how good the air quality is based on a calculation of CO2, PM2.5, and TVOC. The score is accessed from the front display with colour indications as follows:

Air Score / Indication Ring	Default Threshold
Good / Green	100-81
Fair / Yellow	80-41
Poor / Red	40-00

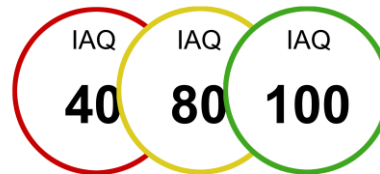

See **IAQ BACnet/Modbus functionality** document to manually adjust the air score thresholds.

Important: On initial power-up allow 24Hrs for the monitor to stabilise and provide fully accurate readings.

The front page shows the real time air score along with the 1-hour average (**1 AVG**) and 8-hour average (**8 AVG**).



IAQ Parameters

Use the touch arrows on the screen to switch to the next page displaying the IAQ parameters, the coloured rings will give an indication of the parameter condition as follows.

Coloured Indication box	
Green	Good
Yellow	Fair
Red	Poor





Optional Features

The IAQ monitor has the following optional features which are turned off as default but can be activated by changing the settings in the **IAQ BACnet/Modbus functionality** document.

Audible alarm: When turned on the alarm symbol will be displayed on the screen and can be muted by touching the alarm symbol.

IAQ score text: When turned on a text message will be displayed under the IAQ score as shown.

Air Score / Indication Ring	Text
Good / Green 	Good
Fair / Yellow 	Fair
Poor / Red 	Poor

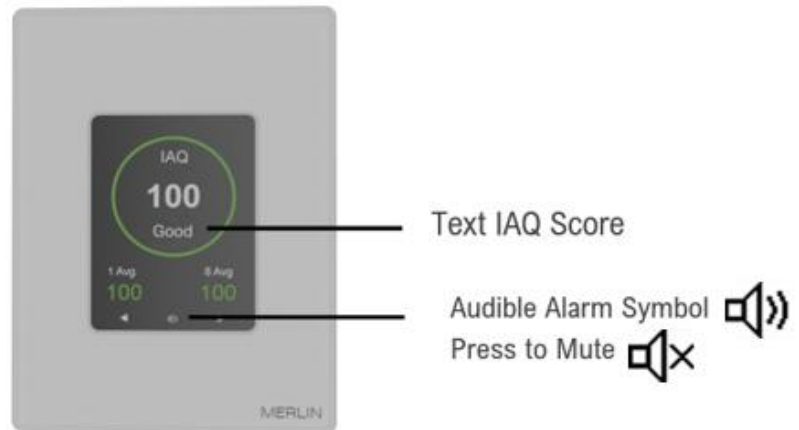

Settings Page

Use the arrows on the screen to switch to the page displaying the IAQ settings as follows.

S/N: Device serial number

Baud Rate: Baud rate as set by the Digital RS-485 Configuration Switches

Mac Address: As set by the Digital RS-485 Configuration Switches

Back Light: The screen brightness can be adjusted Auto/Low/Medium/High

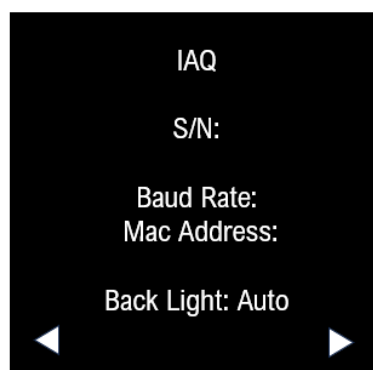

Sensor Parameters

Parameter	Unit	Default Threshold	Measure Range	Accuracy	Resolution
CO2	ppm	Good: 400-599 Fair: 600-1499 Poor: 1500>	0-5000 ppm	± 50ppm+5% reading value	1ppm
PM1.0	µg/m3	Good: 0-15 Fair: 16-56 Poor: 57>	0-1000µg/m ³	0-100 µg /m ³ : ±15µg/m ³ 101-1000 µg /m ³ : ± 15% Reading	1 µg/m3
PM2.5	µg/m3	Good: 0-20 Fair: 21-75 Poor: 76>			
PM10	µg/m3	Good: 0-30 Fair: 31-113 Poor: 114>			
TVOC	ppb	Good: 0-249 Fair: 250-350 Poor: 351>	0-2383*	15% of the measured value	1 ppb
Temp	°C	Good: 15-30*	32-122 °F (0-50°C)	Temperature: <±0.5 °C @ 25 °C	0.1 °F (0.1°C)
Humidity	% RH	Good: 20-70*	0-99% RH	Humidity: <±3.0% RH (20%-80% RH)	0.1% RH

Notes: *

*TVOC using conversion algorithm from VOC Index

* Temp & Humidity will display yellow "Fair" indication outside of the default green "Good" adjustable threshold

IAQ Score

Provides a measurement of the overall air quality based on the measured values of; CO2, Particulate Matter and TVOC, allowing users and facility managers to monitor overall air quality.

Temperature (°C/°F)

Monitoring Temperature can help to maintain a healthy environment, high and low temperatures can cause difficulty concentrating and a loss of productivity.

Relative humidity (%)

A dry environment can cause skin irritation, and high humidity along with high temperature breeds bacteria and mould.

TVOC (ppb)

Volatile organic compounds can be found in building materials and cleaning products, maintaining a low level will protect health by maintaining a toxic compound-free environment.

CO2 (ppm)

CO2 levels may spike as more people occupy a space without adequate ventilation, high levels will increase the likelihood of drowsiness and lethargy.

PM2.5 (µg/m3)

Levels of small particles such as dust, fungi, pollen, and smoke are detrimental to health and can trigger problems like asthma and allergies.

CALIBRATION & MAINTENANCE

Calibration

The IAQ monitor has self-calibration and features that ensure long-term stability and minimum maintenance.



The monitor comes pre-calibrated from the factory and does not need to be re-calibrated in the field. An annual calibration check is advised, a new IAQ monitor, or other suitable reference monitor can be used as a comparison calibration standard.

If measurement deviations are encountered, contact S&S Northern, a correction procedure is available on request, and measurement offset values can be programmed which are listed in the **IAQ BACnet/Modbus functionality** document.

Maintenance

Regular maintenance will be required depending on the environment, for normal environments, a maintenance period of 6 months is recommended, and for installations with a high concentration of dust and poor environmental cleanliness, the maintenance period should be shortened to every 3 months.

General maintenance should be performed as follows: Power down the monitor, carefully remove the cover and remove the dust inside using a suitable small vacuum cleaner.

-  Never use detergents or solvents to clean your device.
-  Never spray air fresheners, hair spray, paint or other aerosols near the device
-  Never paint the device.

Page intentionally left blank

Page intentionally left blank

TECHNICAL SPECIFICATION

Mechanical	Mounting	Wall Mounted
	Entry	½" 12.5mm DIA Rear Entry
	Size (W x H x D)	86 x 114 x 35mm
	Weight (Max)	0.2kg
	Enclosure	ABS UL Flame retardant – IP40
Electrical	24V AC/DC or 110-240VAC Power Rating	12-24VDC(11-32 VDC) / 24VAC,(20-27 VAC) / 110-240VAC 50-60Hz
	Inrush current	< 120mA @ 24VDC
	Communication	127 units max
	Power Consumption	< 2W @ 24VDC
Environmental	Operating Temperature	0 to 50°C
	Storage	10-30°C
	Room Humidity	0 to 95% RH (continuous) non-condensing.
	Atmospheric Pressure	80 to 110Pa
	Altitude	<2000m
	Installation Cat (24V Voltage)	III (Class 3) Pollution Degree 2
I/Os	Digital Networks	RS-485 - BACnet MS/TP / MODBUS RTU
Cable Spec	Power	1.0 – 2.5mm ₂ max
	Digital Output	1.0 – 2.5 mm ₂ twisted pair + ground, shielded cable with 120Ω characteristic impedance.
User Interface	Language	English
	Optional Display	2.8" TFT
	Optional LED/TFT Indication	Green: Power (GOOD AIR QUALITY) Yellow: Warning (FAIR AIR QUALITY) Red: Warning (POOR AIR QUALITY)
Conformance	Safety	BS 61010-1
	Electromagnetic Compatibility	BS 50270
	Other (Applied or Considered)	WELL Performance Standards. CIBSE Part F. BS 50543
Sensors	Carbon Dioxide	CO ₂ (PPM)
	Particulate Matter	PM _{1.0} , PM _{2.5} & PM ₁₀ (ug/m ³)
	Volatile Organic Matter	TVOC (PPB)
	Temperature	°C / °F
	Humidity	% RH

Please pass this manual to the system owner/user.

Date of Installation:	
Installation Location:	
Organisation:	
Stamp/Signature of the installer:	

We recommend all S&S equipment be commissioned by competent/trained engineers to ensure correct installation and operation. We strongly recommend the response and alarm signals are tested and validated once installed. This will ensure the equipment performs as intended and is free from any unforeseen damage caused by transit/installation.

Every effort is made to ensure the accuracy of this document; however, S&S Northern can assume no responsibility for any errors or omissions in this document or their consequences. S&S Northern would greatly appreciate being informed of any errors or omissions that may be found in the content of this document. For information not covered in this document, or if there is a requirement to send comments/corrections, please contact S&S Northern using the contact details given below.

S&S Northern Limited

www.snsnorthern.com

S&S Northern Head Office

Tel: +44 (0) 1257 470983

info@snsnorthern.com

S&S Southeast Division

Tel: +44 (0) 1702 291725

south@snsnorthern.com



S&S Northern is the owner of this document and reserves all rights of modification without prior notice.